

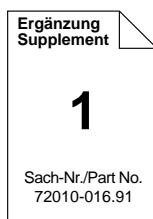

D Btx + 32700 #



Zusätzlich erforderliche Unterlagen für den Komplettservice:

Additionally required Service Manuals for the Complete Service:

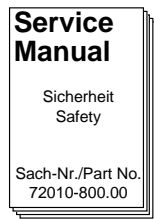
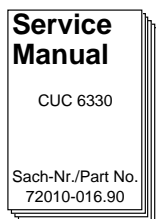

CUC 6330
CUC 6331

CUC 6330		ST 70-705/8 text	(9.21513-02 / G.CD 4475)
Greenville 7002 text	(9.21536-01 / G.CD 8475)	ST 70-728 text	(9.21420-21 / G.CE 1075)
Greenville 7002/8 text	(9.21536-02 / G.CD 8575)		
ST 70-725/8 FT/GB	(9.21506-64 / G.CD 2869)	CUC 6331	
ST 63-725/8 FT/GB	(9.21507-64 / G.CD 2969)	SE 7277 text	(9.21542-01 / G.CE 0424)
ST 70-725/8 text	(9.21506-02 / G.CD 2669)	Sydney ST 872/8 text	(9.21532-02 / G.CD 8775)
ST 63-725/8 text	(9.21507-02 / G.CD 2769)	Sydney ST 872 text	(9.21532-01 / G.CD 8675)
ST 70-720/8 text	(9.21403-02 / G.CC 4475)	ST 72-760/8 text	(9.21521-02 / G.CD 7069)
ST 63-720/8 text	(9.21404-02 / G.CC 5075)	ST 72-760 text	(9.21521-01 / G.CD 6169)
XS 63/81	(9.21422-02 / G.CC 5275)		
XS 70/81	(9.21420-02 / G.CC 5175)		

D

GB

Für diese Geräte gilt das Service Manual CUC 6330.
Diese Ergänzung dokumentiert die Unterschiede bzw. zusätzlichen Bestückungen der Geräte.
Die Bausteinbestückung und die Sachnummern der einzelnen Bausteine entnehmen Sie bitte der Tabelle auf Seite 2.
Grundlage für den Service sind:
– Sicherheitsvorschriften (Sach-Nr. 72010-800.00)
– Service Manual CUC 6330 (Sach-Nr. 72010-016.90)

For these TV sets the Service Manual CUC 6330 is applicable.
This Manual describes the differences and the additionally fitted modules of the TV receivers.
The individual modules and the relevant part numbers are listed in the table on page 2.
Basic instructions for servicing are given in the:
– Safety Instructions (Part No. 72010-800.00)
– Service Manual CUC 6330 (Part No. 72010-016.90)

Inhaltsverzeichnis

	Seite
Modulübersicht	2
Technische Daten	3
Chassisplatte	5
Gesamtschaltplan	9
Moevenentzerrungsplatte 29304-019.95	13
Bedieneinheit 29501-082.11	14
Bedieneinheit 29501-082.31	15
Bedieneinheit 29501-082.40/41	16
ZF Verstärker 29504-162.58	17
Bildrohrplatte 29305-122.11	19
Bildrohrplatte 29305-022.44	20
Ersatzteillisten	21

Table of Contents

	Page
Module List	2
Technical Data	3
Chassis Board	5
General Circuit Diagram	9
N.S. Seagull Raster Correction Board 29304-019.95	13
Control Unit 29501-082.11	14
Control Unit 29501-082.31	15
Control Unit 29501-082.40/41	16
IF Amplifier 29504-162.58	17
CRT Panel 29305-122.11	19
CRT Panel 29305-022.44	20
Spare Parts Lists	21

Modulübersicht / Module List

	Chassis	Tuner	ZF-Verstärker IF Amplifier	Bedieneinheit Control Unit	Bildrohrplatte CRT Panel	Moeven Entzerrerplatte N.S. Sea Gull Raster Corr. PCB	Fernbedienung Remote Control
Greenville 7002 text	29701-094.03	29504-201.21/31	29504-102.57	29501-082.40	29305-122.05	—	29642-061.11
Greenville 7002/8 text	29701-094.07	29504-201.21/31	29504-162.58	29501-082.40	29305-122.05	—	29642-061.11
ST 70-725/8 FT/GB	29701-094.10	29504-201.21/31	29504-162.58	29501-082.11	29305-122.05	—	29642-059.06
ST 63-725/8 FT/GB	29701-094.11	29504-201.21/31	29504-162.58	29501-082.11	29305-122.05	—	29642-059.06
ST 70-725/8 text	29701-094.05	29504-201.21/31	29504-162.58	29501-082.11	29305-122.05	—	29642-059.06
ST 63-725/8 text	29701-094.06	29504-201.21/31	29504-162.58	29501-082.11	29305-122.05	—	29642-059.06
ST 70-720/8 text	29701-094.05	29504-201.21/31	29504-162.58	29501-082.04	29305-122.05	—	29642-059.06
ST 63-720/8 text	29701-094.06	29504-201.21/31	29504-162.58	29501-082.04	29305-122.05	—	29642-059.06
XS 63/81	29701-094.08	29504-201.21/31	29504-162.58	29501-082.12	29305-122.05	—	29642-059.06
XS 70/81	29701-094.07	29504-201.21/31	29504-162.58	29501-082.12	29305-122.05	—	29642-059.06
ST 70-705/8 text	29701-094.05	29504-201.21/31	29504-162.58	29501-082.11	29305-022.44	—	29642-059.06
ST 70-728 text	29701-094.03	29504-201.21/31	29504-102.57	29501-082.12	29305-122.05	—	29642-059.06
SE 7277	29701-094.14	29504-201.21/31	29504-102.57	29501-082.40	29305-122.11	29304-019.95	29642-061.11
Sydney ST 872/8 text	29701-094.15	29504-201.21/31	29504-162.58	29501-082.41	29305-122.11	29304-019.95	29642-061.11
Sydney ST 872 text	29701-094.14	29504-201.21/31	29504-102.57	29501-082.41	29305-122.11	29304-019.95	29642-061.11
ST 72-760/8 text	29701-094.15	29504-201.21/31	29504-162.58	29501-082.31	29305-122.05	29304-019.95	29642-059.06
ST 72-760 text	29701-094.14	29504-201.21/31	29504-102.57	29501-082.31	29305-122.05	29304-019.95	29642-059.06

Technische Daten / Technical Data

	Greenville 7002 text (CUC 6330)	Greenville 7002/8 text (CUC 6330)	ST 70-725/8 FT/GB (CUC 6330)	ST 63-725/8 FT/GB (CUC 6330)	ST 70-725/8 text (CUC 6330)	ST 63-725/8 text (CUC 6330)	ST 70-720/8 text (CUC 6330)	ST 63-720/8 text (CUC 6330)	XS 63/81 (CUC 6330)	XS 70/81 (CUC 6330)	ST 70-705/8 text (CUC 6330)	ST 70-728 text (CUC 6330)	SE 7277 text (CUC 6331)	Sydney ST 872/8 text (CUC 6331)	Sydney ST 872 text (CUC 6331)	ST 72-760/8 text (CUC 6331)	ST 72-760 text (CUC 6331)	
Bildröhre / Picture Tube																		
Sichtbares Bild Visible picture	66 cm	66 cm	66 cm	59 cm	66 cm	59 cm	66 cm	59 cm	59 cm	66 cm	66 cm	66 cm	68 cm	68 cm	68 cm	68 cm	68 cm	
Bildschirmdiagonale Screen diagonale	70 cm (28") FST Black Matrix	70 cm (28") FST Black Matrix	70 cm (28") FST Black Matrix	63 cm (25") FST Black Matrix	70 cm (28") FST Black Matrix	63 cm (25") FST Black Matrix	70 cm (28") FST Black Matrix	63 cm (25") FST Black Matrix	63 cm (25") FST Black Matrix	70 cm (28") FST Black Matrix	70 cm (28") FST Black Matrix	70 cm (28") FST Black Matrix	72 cm (29") MEGATRON S	72 cm (29") MEGATRON S	72 cm (29") MEGATRON S	72 cm (29") MEGATRON S	72 cm (29") MEGATRON S	
Ablenkwinkel Deflection angle	110°	110°	110°	110°	110°	110°	110°	110°	110°	110°	110°	110°	110°	110°	110°	110°	110°	
Bildwechselfrequenz Vertical frequency	50Hz	50Hz	50Hz	50Hz	50Hz	50Hz	50Hz	50Hz	50Hz	50Hz	50Hz	50Hz	50Hz	50Hz	50Hz	50Hz	50Hz	
Elektronik / Electronic																		
Programmspeicherplätze Programme positions	99 + 1 AV	99 + 1 AV	99 + 1 AV	99 + 1 AV	99 + 1 AV	99 + 1 AV	99 + 1 AV	99 + 1 AV	99 + 1 AV	99 + 1 AV	99 + 1 AV	99 + 1 AV	99 + 1 AV	99 + 1 AV	99 + 1 AV	99 + 1 AV	99 + 1 AV	
AV-Auswertung AV evaluation	auf jeden Programmplatz programmierbar / programmable for every programm position																	
Tuner	Kabeltuner-Raster 8MHz für Hyperband / cable tuner - 8MHz spacing for hyperband																	
TV-Normen TV standards	PAL B/G	PAL SECAM (8 Systeme)	PAL SECAM (8 Systeme)	PAL SECAM (8 Systeme)	PAL SECAM (8 Systeme)	PAL SECAM (8 Systeme)	PAL SECAM (8 Systeme)	PAL SECAM (8 Systeme)	PAL SECAM (8 Systeme)	PAL SECAM (8 Systeme)	PAL SECAM (8 Systeme)	PAL SECAM (8 Systeme)	PAL B/G	PAL B/G	PAL SECAM (8 Systeme)	PAL B/G	PAL SECAM (8 Systeme)	PAL B/G
Musikleistung Music power	2 X 8W	2 X 8W	2 X 8W	2 X 8W	2 X 8W	2 X 8W	2 X 8W	2 X 8W	2 X 8W	2 X 8W	2 X 8W	2 X 8W	2 X 8W	2 X 8W	2 X 8W	2 X 8W	2 X 8W	2 X 8W
Anschlüsse Front / Connections front																		
Kopfhörer Headphones	Mono 3,5 mm Klincken-Schaltbuchse (schaltet eingebauten Lautsprecher ab) Mono 3,5 mm jack switching socket (switches off the built-in loudspeaker)																	
Audio IN	2 x Cinch Audio	2 x Cinch Audio	2 x Cinch Audio	2 x Cinch Audio	2 x Cinch Audio	2 x Cinch Audio	2 x Cinch Audio	2 x Cinch Audio	2 x Cinch Audio	–	–	2 x Cinch Audio	–	2 x Cinch Audio	2 x Cinch Audio	2 x Cinch Audio	2 x Cinch Audio	2 x Cinch Audio
Video IN	Cinch FBAS	Cinch FBAS	Cinch FBAS	Cinch FBAS	Cinch FBAS	Cinch FBAS	Cinch FBAS	Cinch FBAS	Cinch FBAS	–	–	Cinch FBAS	–	Cinch FBAS	Cinch FBAS	Cinch FBAS	Cinch FBAS	Cinch FBAS
Anschlüsse Rückwand / Connections rear panel																		
Euro AV (schwarz, black)	voll belegt fully wired	voll belegt fully wired	voll belegt fully wired	voll belegt fully wired	voll belegt fully wired	voll belegt fully wired	voll belegt fully wired	voll belegt fully wired	voll belegt fully wired	voll belegt fully wired	voll belegt fully wired	voll belegt fully wired	voll belegt fully wired	voll belegt fully wired	voll belegt fully wired	voll belegt fully wired	voll belegt fully wired	voll belegt fully wired
Netzteil / Mains Stage																		
Netzspannung (Regelbereich) Mains voltage (variable)	165 ...265V	165 ...265V	165 ...265V	165 ...265V	165 ...265V	165 ...265V	165 ...265V	165 ...265V	165 ...265V	165 ...265V	165 ...265V	165 ...265V	165 ...265V	165 ...265V	165 ...265V	165 ...265V	165 ...265V	165 ...265V
Netzfrequenz Mains frequency	50 / 60Hz	50 / 60Hz	50 / 60Hz	50 / 60Hz	50 / 60Hz	50 / 60Hz	50 / 60Hz	50 / 60Hz	50 / 60Hz	50 / 60Hz	50 / 60Hz	50 / 60Hz	50 / 60Hz	50 / 60Hz	50 / 60Hz	50 / 60Hz	50 / 60Hz	50 / 60Hz
Leistungsaufnahme Power consumption	ca. 80W	ca. 80W	ca. 80W	ca. 80W	ca. 80W	ca. 80W	ca. 80W	ca. 80W	ca. 75W	ca. 75W	ca. 80W	ca. 80W	ca. 80W	ca. 90W	ca. 90W	ca. 90W	ca. 90W	ca. 90W
Standby	ca. 8W	ca. 8W	ca. 8W	ca. 8W	ca. 8W	ca. 8W	ca. 8W	ca. 9W	ca. 8W	ca. 8W	ca. 9W	ca. 8W	ca. 8W	ca. 5W	ca. 5W	ca. 5W	ca. 5W	ca. 5W

Chassisplatte / Chassis Board

Lötseite, Ansicht von unten
Solder side, bottom view

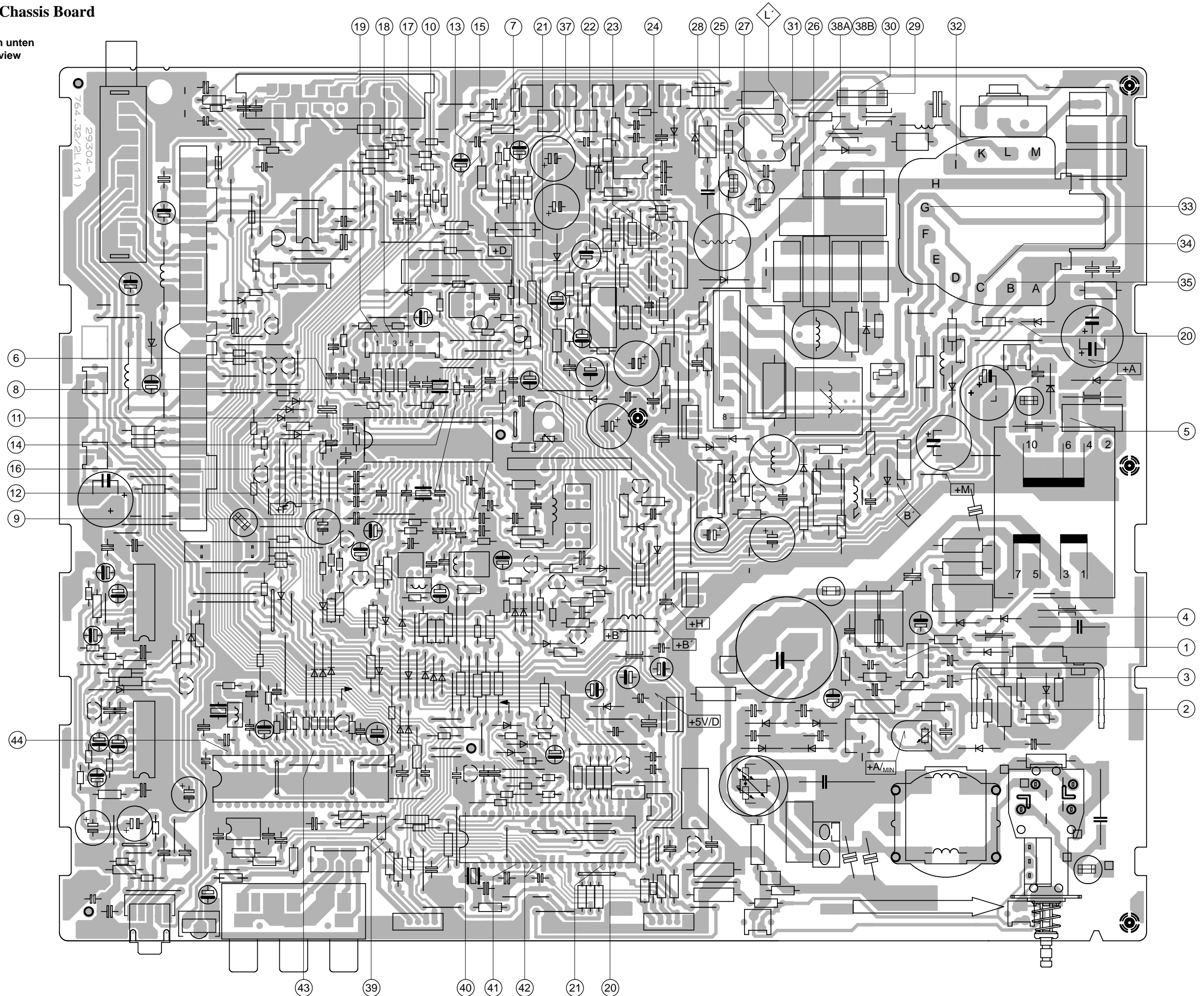

Chassisplatte / Chassis Board

Bestückungsseite, Ansicht von oben
Component side, top view

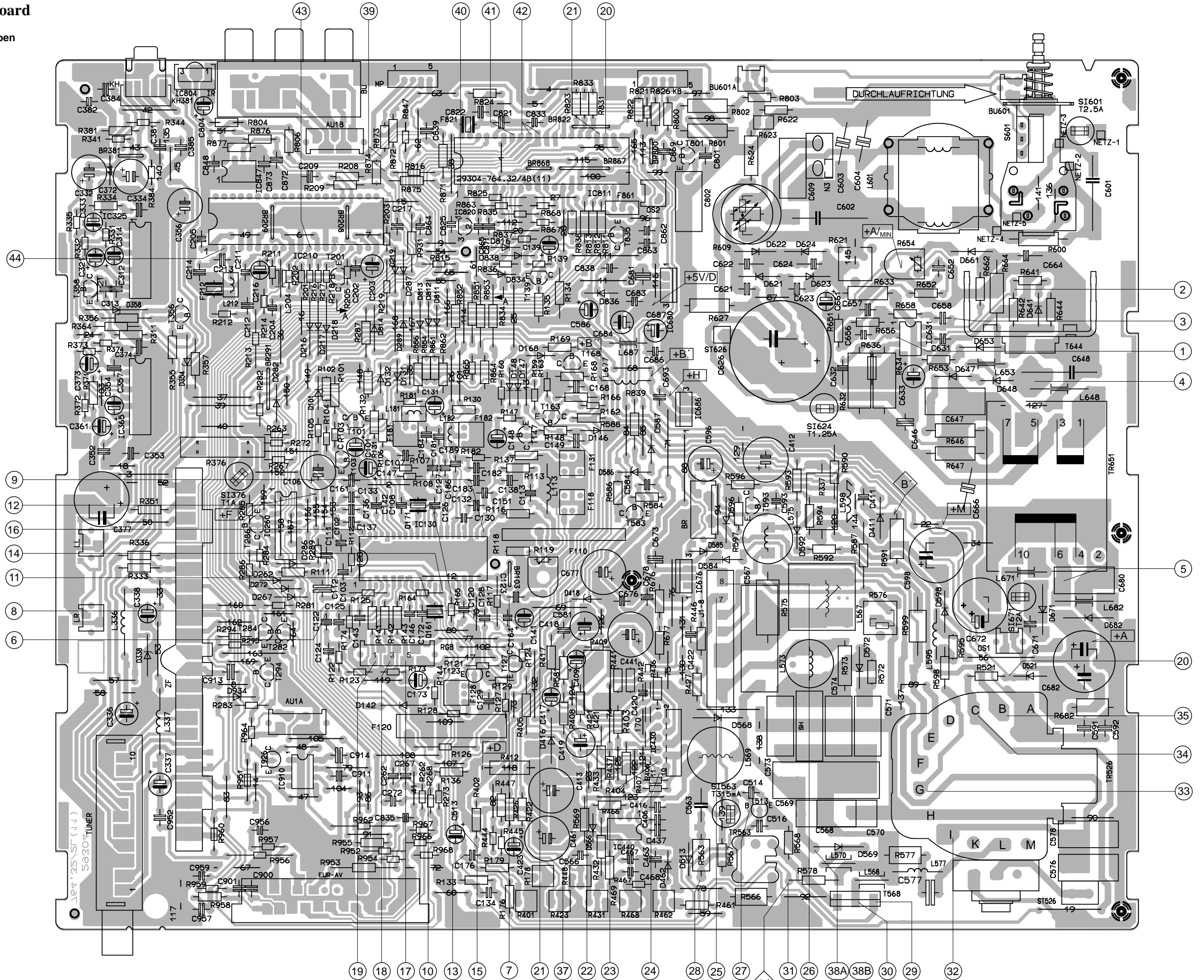

Gesamtschaltplan / General Circuit Diagram

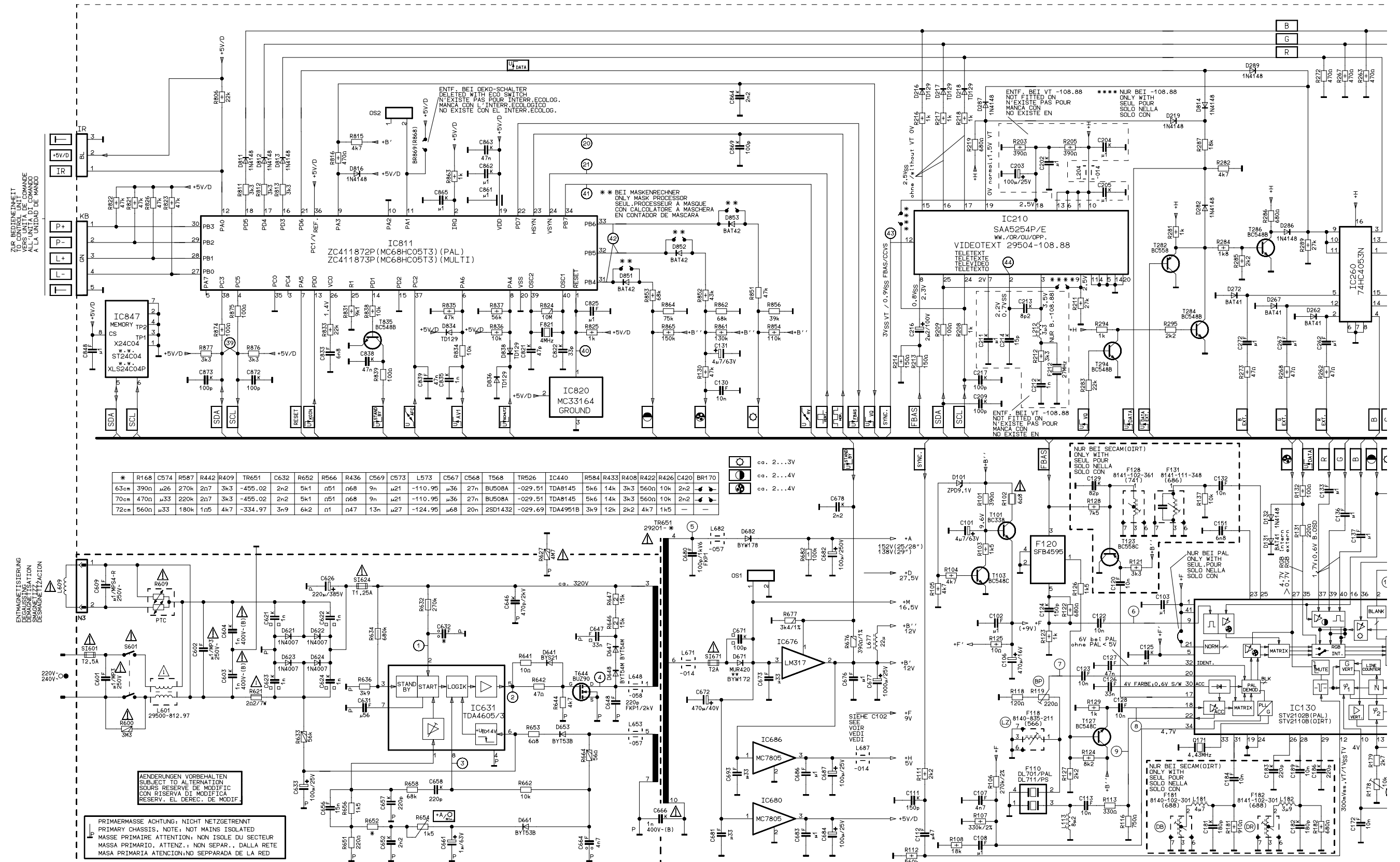

Gesamtschaltplan / General Circuit Diagram

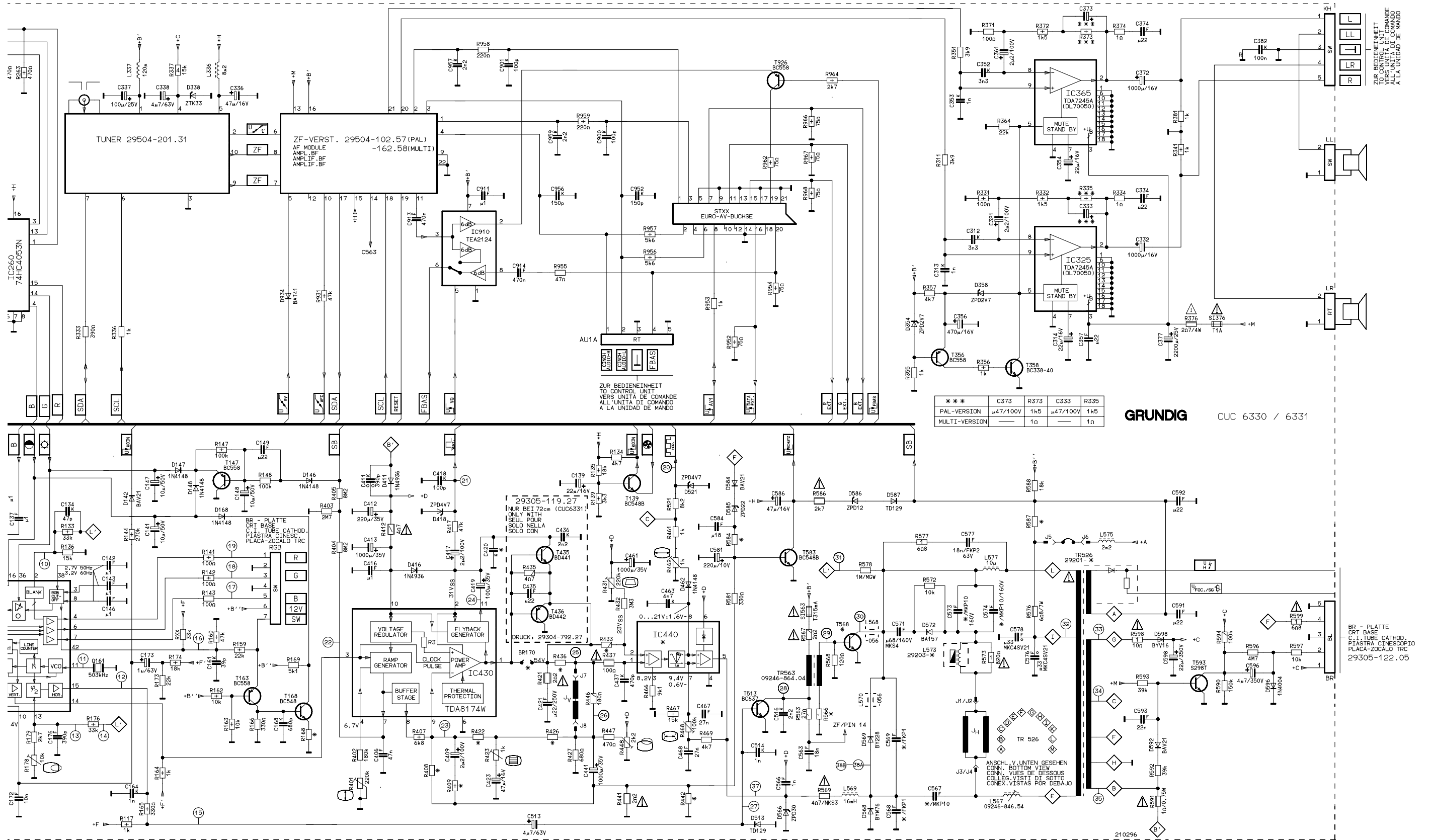

GRUNDIG CUC 6330 / 6331

Mövenentzerrungsplatte / N.S. Seagull Raster Correction Board 29304-019.95

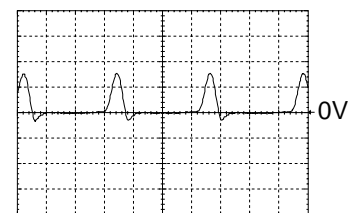
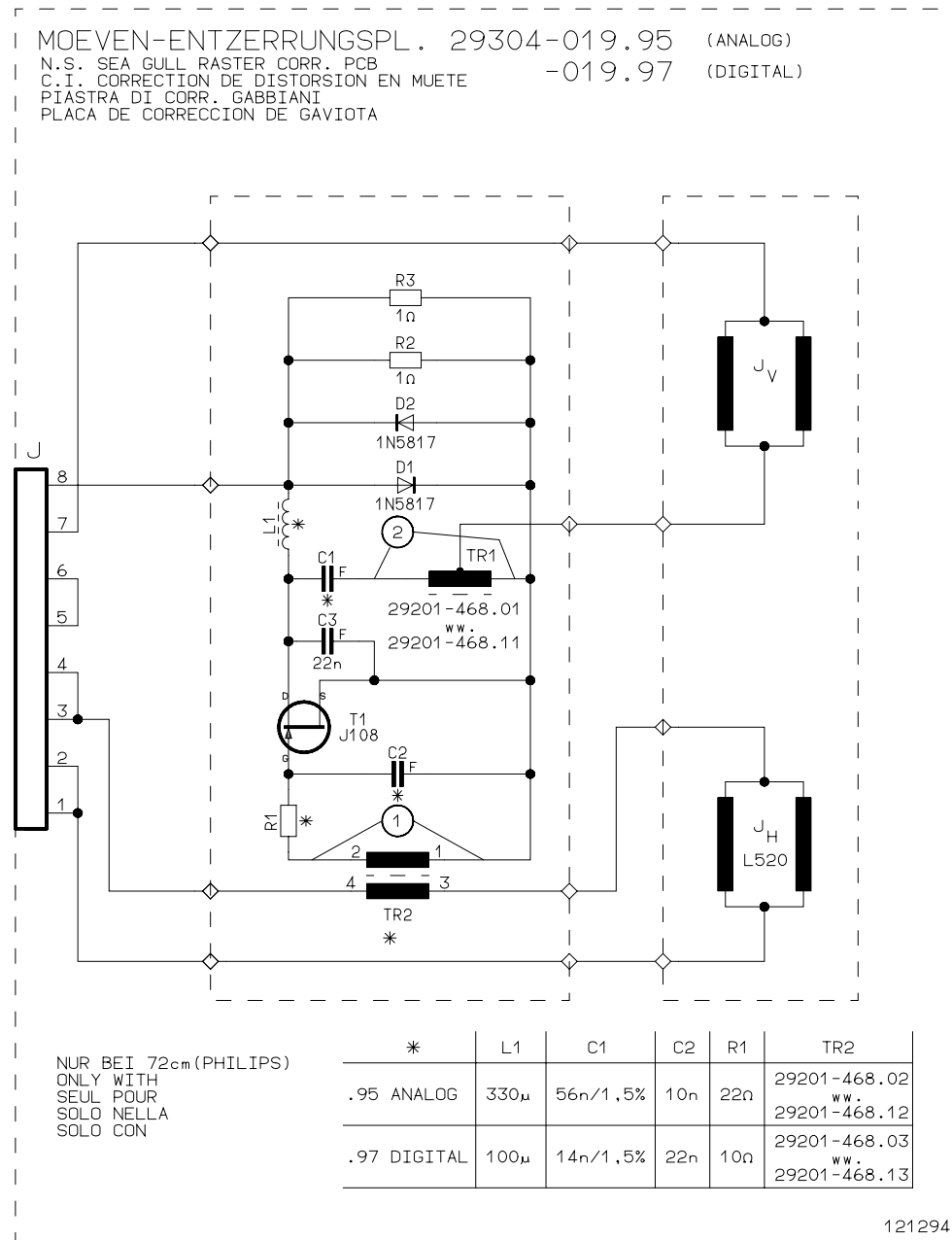

① 15V_{SS}/cm, 10 μ s/cm

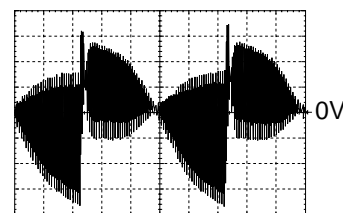

② 15V_{SS}/cm, 10 μ s/cm

Bedieneinheit / Control Unit 29501-082.11

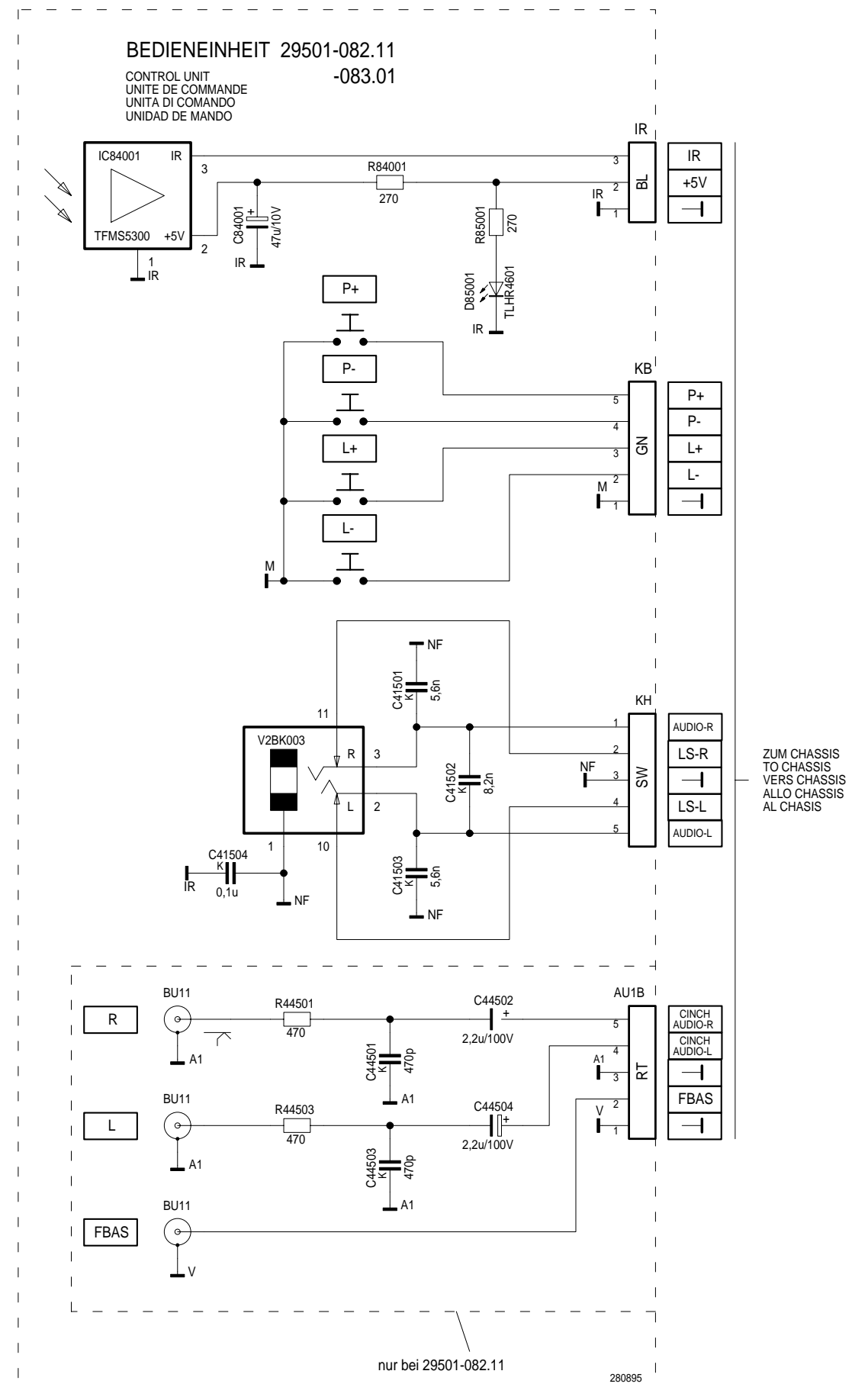

Bedieneinheit / Control Unit 29501-082.31

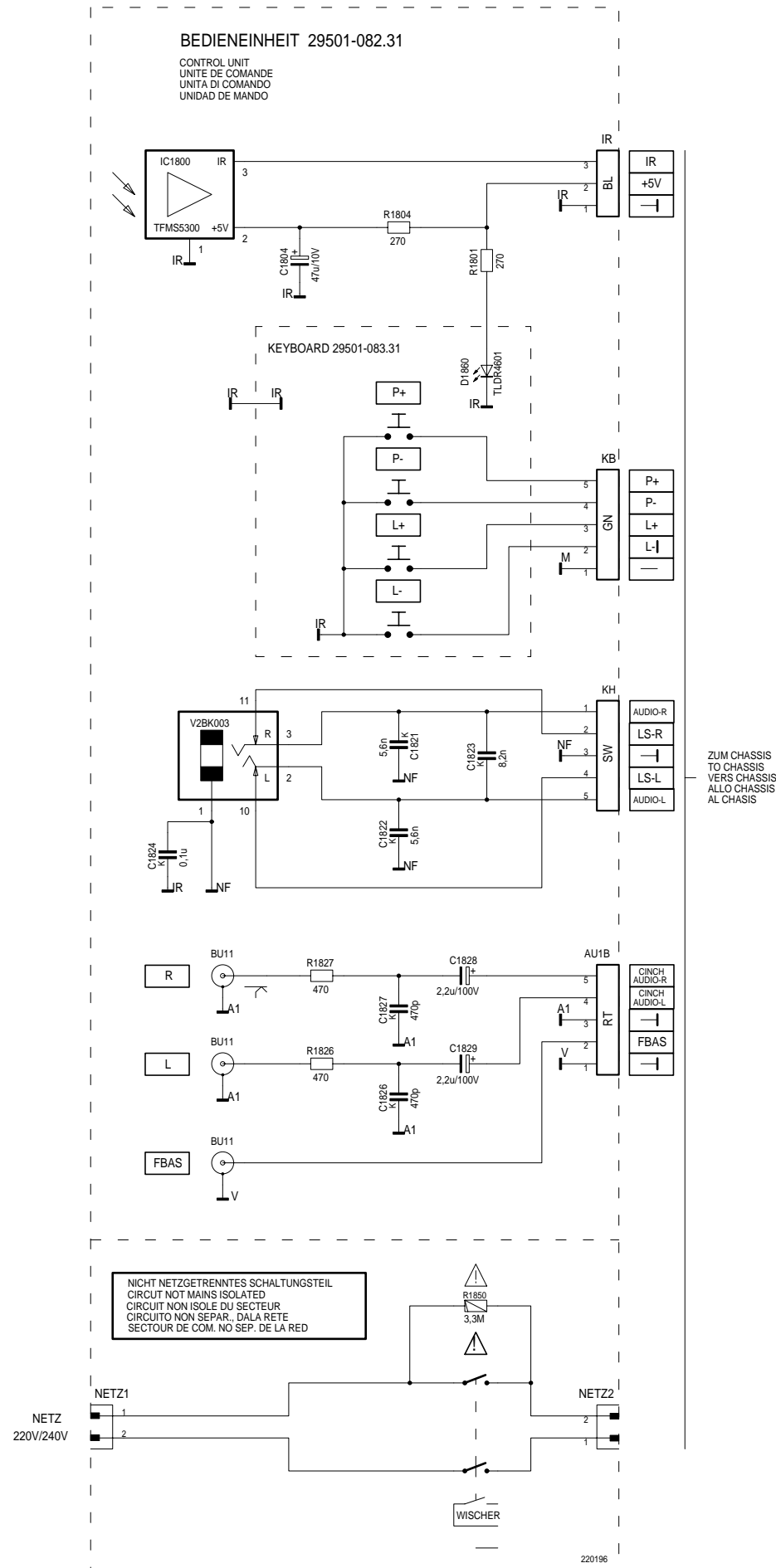

Bedieneinheit / Control Unit 29501-082.40 / 41

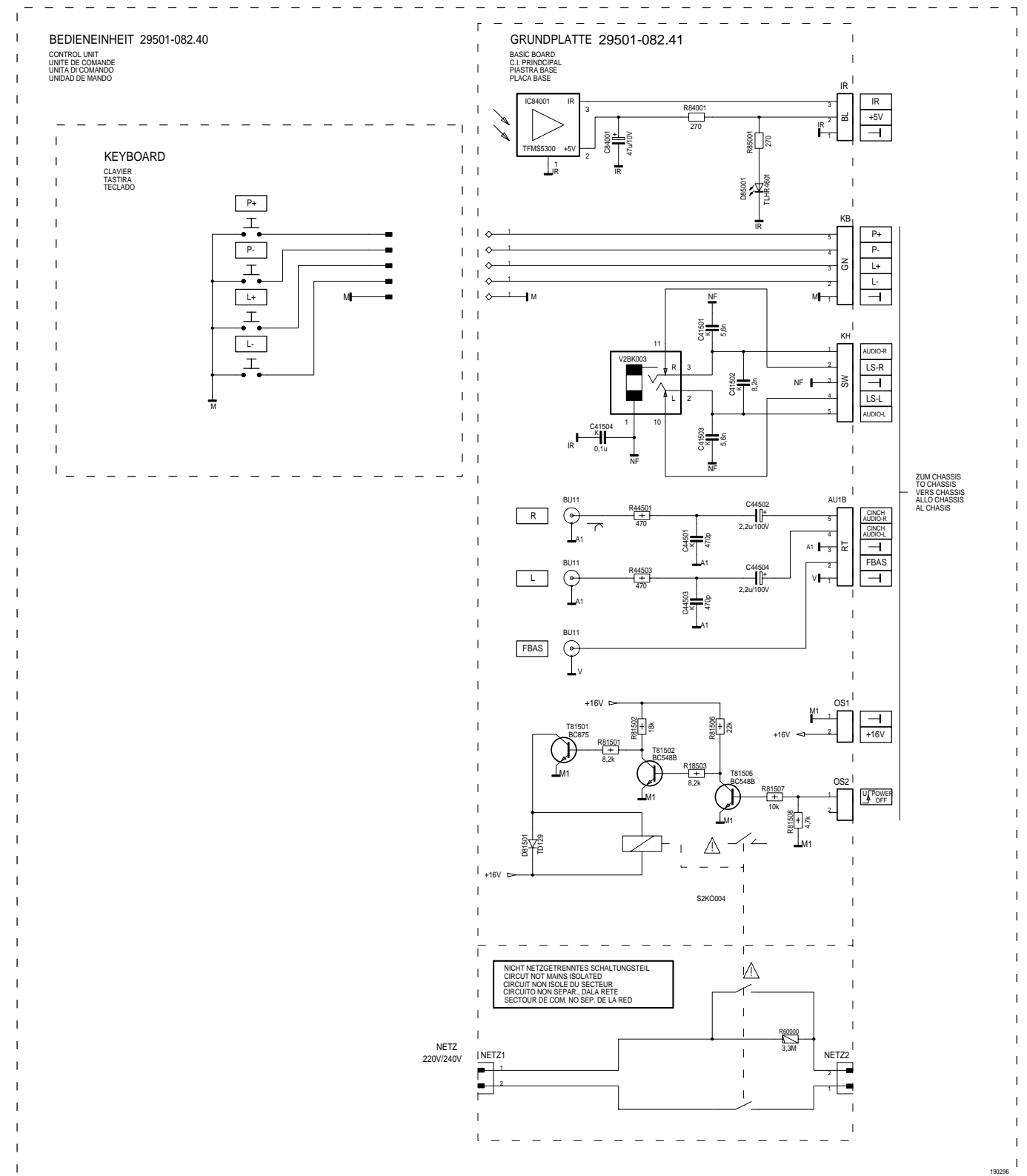

ZF-Verstärker / IF Amplifier 29504-162.58

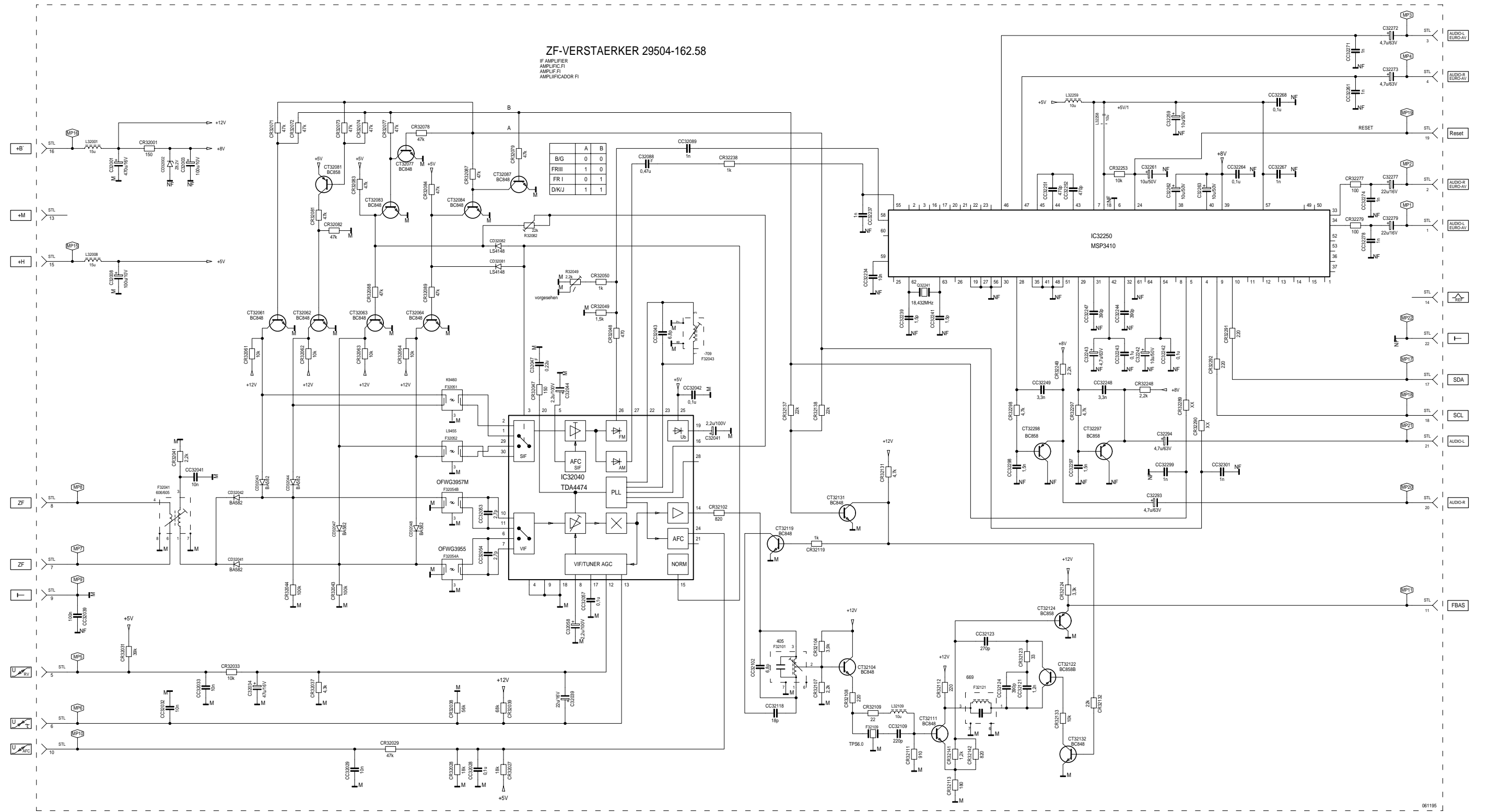

GRUNDIGErsatzteilliste
Spare Parts List

D Btx * 32700 #

CUC 6330**4 / 96**

SACH-NR. / PART NO.: 29701-094.03/.05/.06/.07/.08/.10/.11/.18/.19

POS. NR. POS. NO.	ABB. FIG.	SACHNUMMER PART NUMBER	ANZ. QUA.	BEZEICHNUNG DESCRIPTION	DESCRIPTION DESCRIPTION
0001.000 WW.		29504-201.31		TUNER CHIP/ECO 1200	TUNER CHIP/ECO 1200
0002.000		29504-201.21		CHIP-TUNER/ATA 1200	CHIP-TUNER/ATA 1200
0002.050		29504-102.57	X	ZF-BAUSTEIN .03/18	IF MODULE .03/18
0002.100		29504-162.58	X	BAUSTEIN ZF-MULTI .05/.06/.07/.08/.10/.11/19	MODULE IF-MULTI .05/.06/.07/.08/.10/.11/19
0003.000		29504-108.88	X	BAUSTEIN VIDEO-TEXT .10/.11	MODULE VIDEO-TEXT .10/.11
0004.000		29700-597.05		HALTER BAUSTEIN ZF	HOLDER MODULE IF
0005.000		29303-119.06		PERIBUCHSE SCHWARZ	PERI SOCKET BLACK
0011.000		29700-608.07		ABDECKUNG BUCHSE EURO-AV	COVER SOCKET EURO-AV
0011.000		29303-153.13	3	MONTAGECLIP IC 676/680/686	MOUNTING CLIP IC 676/680/686
0011.000		29303-153.02	2	MONTAGECLIP T568/IC430	MOUNTING CLIP T568/IC430
0012.000		29303-153.16		MONTAGECLIP T644	MOUNTING CLIP T644
0013.000		29303-156.03		GLIMMERSCHEIBE T568 .03/.05/.06/.07/08	MICA WASHER T568 .03/.05/.06/.07/08
0014.000		29303-156.20	2	WAERMELEITFOLIE T644/IC676	HEAT CONDUCTING FOIL T644/IC676
0015.000		29303-156.23		WAERMELEITFOLIE T568 .10/.11/.18/19	HEAT CONDUCTING FOIL T568 .10/.11/.18/19
0030.000	△	29303-399.03		GERAETESTECKER M.KABEL	APPLIANCE PLUG
0040.000	△	29703-291.21		NETZSCHALTER	POWER SWITCH
WW.	△	29703-291.31		NETZSCHALTER	POWER SWITCH

X = SIEHE GESONDERTE E-LISTE X = SEE SEPARATE PARTS LIST
WW. = WAHLWEISE WW. = OPTIONAL

POS. NR. POS. NO.	SACHNUMMER PART NUMBER	BEZEICHNUNG DESCRIPTION
C	8140-540-104	EMIFIL 0,1 UF
C 125	8668-203-023	ABBLOCK-C 0,1 UF -GR 25V
C 202	8668-203-123	ABBLOCK-C 0,1 UF -GR 25V
C 204	8668-203-023	ABBLOCK-C 0,1 UF -GR 25V
C 205	8668-203-123	ABBLOCK-C 0,1 UF -GR 25V
C 211	8668-203-123	ABBLOCK-C 0,1 UF -GR 25V
C 332	8452-995-104	ELKO CA 1000UF 16V
C 372	8452-995-104	ELKO CA 1000UF 16V
C 377	8452-996-148	ELKO CB 1000UF 20% 25V
C 382	8668-203-023	ABBLOCK-C 0,1 UF -GR 25V
C 413	8452-996-187	ELKO CB 1000UF 35V
C 441	8452-996-187	ELKO CB 1000UF 35V
C 461	8452-996-187	ELKO CB 1000UF 35V
C 569	8515-911-114	KF 35 9000PF 3,5% 1500V
C 601	△ 8511-793-020	MP 3 0,1 UF 20% 250VW
C 602	△ 8511-793-020	MP 3 0,1 UF 20% 250VW
C 603	△ 8660-098-234	SI-KERKO B-SS 1000PF 20% 400V
C 604	△ 8660-098-234	SI-KERKO B-SS 1000PF 20% 400V
C 621	8650-081-125	HV-KERKO 1000PF 20% 1KV
C 622	8650-081-125	HV-KERKO 1000PF 20% 1KV
C 623	8650-081-125	HV-KERKO 1000PF 20% 1KV
C 624	8650-081-125	HV-KERKO 1000PF 20% 1KV
C 646	8650-067-486	HV-KERKO 470PF 20% 2KV
C 648	8515-911-605	FKP1 220PF 5% 2000V
C 666	△ 8660-098-234	SI-KERKO B-SS 1000PF 20% 400V

POS. NR. POS. NO.	SACHNUMMER PART NUMBER	BEZEICHNUNG DESCRIPTION
C 671	8650-067-046	HV-KERKO 100PF 20% 1KV
C 677	8452-996-148	ELKO CB 1000UF 20% 25V
C 680	8515-911-038	FKP1 1000PF 10% 1600V
C 862	8668-203-023	ABBLOCK-C 0,1 UF -GR 25V
C 865	8668-203-023	ABBLOCK-C 0,1 UF -GR 25V
D 101	8309-720-091	Z DIODE 9,1 C 0,5W
D 131	8309-198-040	DIODE BAT 41 (TYP 4)
D 132	8309-215-045	DIODE 1 N 4148
D 142	8309-200-021	DIODE BAV 21 ITT
D 146	8309-215-045	DIODE 1 N 4148
D 147	8309-215-045	DIODE 1 N 4148
D 148	8309-215-045	DIODE 1 N 4148
D 168	8309-215-045	DIODE 1 N 4148
D 216	8309-214-010	DIODE TD 129 -GA
D 217	8309-214-010	DIODE TD 129 -GA
D 218	8309-214-010	DIODE TD 129 -GA
D 219	8309-214-010	DIODE TD 129 -GA
D 338	8305-306-003	IC ZTK 33 B/C DPD ITT
D 354	8309-720-027	Z DIODE 2,7 C 0,5W
D 358	8309-720-027	Z DIODE 2,7 C 0,5W
D 411	8309-210-138	DIODE IN4936 DIO/FAG/ITT/
D 416	8309-210-138	DIODE IN4936 DIO/FAG/ITT/
D 418	8309-720-046	Z DIODE 4,7 B 0,5W

POS. NR. POS. NO.	SACHNUMMER PART NUMBER	BEZEICHNUNG DESCRIPTION
D 462	8309-215-045	DIODE 1 N 4148
D 513	8309-214-010	DIODE TD 129 -GA
D 521	8309-720-046	Z DIODE 4,7 B 0,5W
D 566	8309-720-331	Z DIODE 30 C 0,5W
D 568	8309-517-076	DIODE BYW 76 TFK/GI
D 569	8309-204-228	DIODE BY 228 PHI/GI/TFK
D 572	8309-201-103	DIODE BA157/RGP10G GI
D 584	8309-200-021	DIODE BAV 21 ITT
D 585	8309-720-221	Z DIODE 22 B 0,5W
D 586	8309-720-112	Z DIODE 12 C 0,5W
D 587	8309-214-010	DIODE TD 129 -GA
D 592	8309-200-021	DIODE BAV 21 ITT
D 596	8309-215-020	DIODE 1 N 4004 -GA
D 598	△ 8309-204-268	DIODE BYV 16 TFK/BYV 96E/
D 621	8309-215-127	DIODE 1 N 4007 -GA
D 622	8309-215-127	DIODE 1 N 4007 -GA
D 623	8309-215-127	DIODE 1 N 4007 -GA
D 624	8309-215-127	DIODE 1 N 4007 -GA
D 641	8309-518-023	DIODE BYS 21-45 SIE
D 647	8309-516-854	DIODE BYT 54 M
D 648	8309-516-854	DIODE BYT 54 M
D 653	8309-516-754	DIODE BYT53B TFK/ EGP10B
D 661	8309-516-754	DIODE BYT53B TFK/ EGP10B
D 671	△ 8309-820-420	DIODE MUR 420
WW.	△ 8309-517-172	DIODE BYW 172 D/SK 3 G F0
D 682	8309-517-178	DIODE BYW 178/SK 3 G D08/
D 811	8309-215-045	DIODE 1 N 4148
D 812	8309-215-045	DIODE 1 N 4148
D 813	8309-215-045	DIODE 1 N 4148
D 814	8309-215-045	DIODE 1 N 4148
D 834	8309-214-010	DIODE TD 129 -GA
D 836	8309-214-010	DIODE TD 129 -GA
D 838	8309-214-010	DIODE TD 129 -GA
D 851	8309-198-542	DIODE BAT 42/43/BAT 85/86
D 852	8309-198-542	DIODE BAT 42/43/BAT 85/86
D 853	8309-198-542	DIODE BAT 42/43/BAT 85/86
D 934	8309-198-040	DIODE BAT 41 (TYP 4)
F 110	29303-117.04	VERZOEGERUNGSLEITUNG
F 118	8140-535-211	SPULE 7X7 211
F 120	8140-601-600	FILTER SFB 4595 TDK
F 212	8382-336-270	QUARZ 27 MHZ
F 821	8602-331-085	CER.RES.85 4,00 MHZ
IC 130	8305-125-103	IC STV2102B SGS
IC 210	8305-303-624	IC SAA5254P/E PHI
IC 325	8305-367-245	IC TDA 7245 A SGS
IC 365	8305-367-245	IC TDA 7245 A SGS
IC 430	8305-338-174	IC TDA 8174 W
IC 440	8305-338-145	IC TDA 8145
IC 631	8305-354-605	IC TDA 4605/3
IC 676	8305-204-317	IC LM 317 T NSC/MOT/
IC 680	8305-205-706	IC MC 7805 CT MOT
IC 686	8305-205-706	IC MC 7805 CT MOT
IC 811	8305-684-388	IC ZC411876P (MC38HC05T3)
IC 820	8305-210-064	IC MC 33164 P-5RP
IC 847	8305-602-405	IC X 24 C 04 XICOR
IC 910	8305-362-124	IC TEA 2124
L 113	8140-526-014	DR AX 0309-GA 6,8UH
L 204	8104-982-014	DAEMPUNGSPERLE
L 212	8140-526-437	DR ST 0309-GRP 3,3UH
L 336	8140-505-247	DR A AX-GA 8,2UH
L 337	8140-505-075	DR A AX-GA 120UH
L 567	09246-846.24	BRUECKENSPULE (110) 1,3MH
L 568	8104-982-056	FERRITPERLE HF 70 BTL
L 569	09245-405.08	O/W AUSKOPPELSPULE
L 570	8104-982-056	FERRITPERLE HF 70 BTL
L 573	29203-110.97	LINEARITAETSREGLER

POS. NR. POS. NO.	SACHNUMMER PART NUMBER	BEZEICHNUNG DESCRIPTION
L 575	09240-110.51	DROSSEL 2,2 MH
L 577	8140-526-412	DR AX 0411 10UH
L 601	△ 29500-812.97	FUNKENTSTOERDROSSEL
L 648	8104-982-057	FERRITPERLE-GA 3,6UH
L 653	8104-982-058	FERRITPERLE-GA 1,7UH
L 671	8104-982-014	DAEMPUNGSPERLE
L 677	8140-525-969	DR AX 0411-GA 22UH
L 682	8104-982-057	FERRITPERLE-GA 3,6UH
L 687	8104-982-014	DAEMPUNGSPERLE
Q 161	8602-099-503	CER.SCHWINGER CSB 503 F12
Q 171	8382-121-044	QUARZ 4,433619 MHZ
R 102	△ 8701-118-021	KSW SI B 6,8 OHM 5% -GA
R 116	8700-007-470	KSW AX 0207-GA 750 OHM
R 119	8790-047-117	ESTR.SK10 220 OHM
R 169	8700-007-490	KSW AX 0207-GA 5,1 KOHM
R 178	8790-250-051	ESTR.PPK10-A 10 KOHM LIN
R 337	△ 8705-370-134	MOW LI 0922 15 KOHM 5%
R 376	△ 8732-292-411	DRW 4 2,7 OHM 10% KP292-0
R 401	8796-103-167	ESTR P6A 220 KOHM LIN N6
R 403	8700-007-555	KSW AX 0207-GA 2,7 MOHM
R 404	8700-007-555	KSW AX 0207-GA 2,2 MOHM
R 405	8700-007-167	KSW AX 0207-GA 8,2 MOHM
R 412	△ 8700-252-017	KSW AX 0414 NE 4,7 OHM
R 421	△ 8701-118-009	KSW SI B 2,2 OHM 5% -GA
R 423	8796-103-135	ESTR P6A 1 KOHM LIN N6 P
R 431	8796-103-167	ESTR P6A 220 KOHM LIN N6
R 432	8700-005-757	KSW AX 0207-GA 3,3 MOHM
R 433	8765-198-100	MSW 0207 13 KOHM 1% TK50
R 436	8700-007-397	KSW AX 0207-GA 0,68 OHM
R 437	△ 8700-007-449	KSW AX 0207-GA 100 OHM
R 441	△ 8700-229-009	KSW AX 0207-GA NB 2,2 OHM
R 448	8773-297-040	ESTR.P 2,2 KOHM LIN PHI
R 462	8796-103-135	ESTR P6A 1 KOHM LIN N6 P
R 466	8700-007-496	KSW AX 0207-GA 9,1 KOHM
R 468	8796-103-164	ESTR P6A 100 KOHM LIN N6
R 563	△ 8705-329-033	MOW LI 0411 27 OHM 5%
R 566	△ 8705-328-993	MOW LI 0411 0,51 OHM 10%
R 567	△ 8701-118-009	KSW SI B 2,2 OHM 5% -GA
R 569	△ 8701-230-817	NKS 3 4,7 OHM 5% ROE
R 572	△ 8700-121-297	KSW LI 0207 10 KOHM
R 573	△ 8705-221-271	MOW AX 0411 820 OHM 10%
R 576	8730-179-221	DRW 7 ST 6,8 OHM 10%
R 577	△ 8705-329-221	MOW LI 0411 6,8 OHM 10%
R 578	8710-338-145	MGW AX 1 MOHM 5% VR 37
R 586	△ 8700-329-083	KSW LI 0207-NB 2,7 KOHM
R 591	△ 8735-003-201	DRW 0,75W 1 OHM 10% BWF23
R 596	8700-005-761	KSW AX 0207-GA 4,7 MOHM
R 598	△ 8705-221-225	MOW AX 0411-GA 10 OHM
R 599	△ 8705-321-221	MOW LI 0411 6,8 OHM 10%
R 609	△ 8311-200-010	DIO-PTC
R 621	△ 8311-005-017	NTC 4,7 OHM 30%
R 627	△ 8766-349-161	MSW LI 0414 4,7 MOHM
R 633	△ 8766-357-119	MSW LI 0414 82 KOHM 5%
R 646	△ 8705-369-301	MOW LI 0617 15 KOHM 10%
R 647	△ 8705-369-301	MOW LI 0617 15 KOHM 10%
R 652	8700-007-490	KSW AX 0207-GA 5,1 KOHM
R 654	8790-050-037	ESTR.SK10-A 1,5 KOHM LIN
R 677	8765-198-539	MSW 0207 3,4 KOHM 1% TK50
R 682	△ 8705-329-321	MOW LI 0411 10 KOHM 10%
R 824	8765-098-169	MSW 0207 10 MOHM 5% TK100
R 831	8700-007-496	KSW AX 0207-GA 9,1 KOHM
R 852	8700-011-312	KSW AX 0204-GA 43 KOHM
R 854	8700-007-522	KSW AX 0207-GA 110 KOHM
R 861	8700-007-524	KSW AX 0207-GA 130 KOHM
R 864	8700-007-518	KSW AX 0207-GA 75 KOHM
R 933	8700-011-351	KSW AX 0204-GA 1,8 MOHM
R 952	8700-011-246	KSW AX 0204-GA 75 OHM

POS. NR. POS. NO.	SACHNUMMER PART NUMBER	BEZEICHNUNG DESCRIPTION
R 954	8700-011-246	KSW AX 0204-GA 75 OHM
R 962	8700-007-446	KSW AX 0207-GA 75 OHM
R 966	8700-011-246	KSW AX 0204-GA 75 OHM
R 967	8700-011-246	KSW AX 0204-GA 75 OHM
R 968	8700-011-246	KSW AX 0204-GA 75 OHM
SI 376	△ 8315-618-200	LOET-SI.-GR 1 A/T
SI 563	△ 8315-612-027	LOET-SI.-GR 315 MA/T
SI 601	△ 8315-621-027	LOET-SI.-GR 2,5 A/T
SI 624	△ 8315-618-225	LOET-SI.-GR 1,25 A/T
SI 671	△ 8315-620-225	LOET-SI.-GR 2 A/T
T 101	8303-272-338	TRANS.BC 338-25
T 103	8303-206-548	TRANS.BC 548 C
T 127	8303-206-548	TRANS.BC 548 C
T 139	8302-201-549	TRANS.BC 549 B
T 147	8302-200-555	TRANS.BC 558 A SIE/VAL
T 163	8302-200-555	TRANS.BC 558 A SIE/VAL
T 168	8302-201-553	TRANS.BC 548 B
T 356	8302-200-555	TRANS.BC 558 A SIE/VAL
T 358	8303-283-338	TRANS.BC 338-40
T 513	8303-285-637	TRANS.BC 637
T 568	8302-260-507	TRANS.BU 508 A ON 4542
T 583	8302-201-549	TRANS.BC 549 B
T 593	8303-401-299	TRANS.S 298 T TFK/PBF 259
T 644	8302-269-089	TRANS.BUZ 90
T 835	8302-201-549	TRANS.BC 549 B
T 926	8302-200-555	TRANS.BC 558 A SIE/VAL
TR 526	△ 29201-029.51	DIODEN-SPLIT TRAF0 KPL.
TR 563	△ 09246-864.04	TREIBERTRAF0
WW.	△ 29201-502.97	SPERRWANDLERTRAF0 KPL.
TR 651	△ 29201-455.02	SPERRWANDLERTRAF0 KPL.

Es gelten die Vorschriften und Sicherheitshinweise gemäß dem Service Manual "Sicherheit", Sach-Nummer 72010-800.00, sowie zusätzlich die eventuell abweichenden, landesspezifischen Vorschriften!



The regulations and safety instructions shall be valid as provided by the "Safety" Service Manual, part number 72010-800.00, as well as the respective national deviations.

POS. NR. POS. NO.	SACHNUMMER PART NUMBER	BEZEICHNUNG DESCRIPTION
----------------------	---------------------------	----------------------------

GRUNDIG Ersatzteilliste Spare Parts List



ⓓ Btx * 32700 #

4 / 96

CUC 6331

SACH-NR. / PART NO.: 29701-094.14/.15/.16/.17

POS. NR. POS. NO.	ABB. FIG.	SACHNUMMER PART NUMBER	ANZ. QUA.	BEZEICHNUNG DESCRIPTION	ⓓ	ⓖⓑ
0001.000		29504-201.31		TUNER CHIP/ECO 1200		TUNER CHIP/ECO 1200
WWW.		29504-201.21		CHIP-TUNER/ATA 1200		CHIP-TUNER/ATA 1200
0002.000		29504-102.57	X	ZF-BAUSTEIN .14/.16		IF MODULE .14/.16
0002.000		29504-162.58	X	BAUSTEIN ZF-MULTI .15/.17		MODULE IF MULTI .15/.17
0003.000		29305-119.27		VERTIKAL-ENDSTUFENPLATTE		VERTICAL OUTPUT STAGE
0004.000		29303-119.06		EURO-AV BUCHSE SW		PERI SOCKET BLACK
0005.000	△	29303-399.31		GERAETESTECKER M.KABEL KP		APPLIANCE PLUG W. CABLE
0006.000		29700-435.01		ABDECKUNG NETZ		COVER
0007.000		29700-597.05		BAUSTEINHALTER		HOLDER MODULE
0008.000		29700-608.07		BUCHSENABDECKUNG F.1 EURO		SOCKET COVER
0011.000		29303-153.16		MONTAGECLIP T644		MOUNTING CLIP T644
0012.000		29303-153.02		MONTAGECLIP T568/IC430		MOUNTING CLIP T568/IC430
0013.000		29303-153.12		MONTAGECLIP IC676/680/686		MOUNTING CLIP IC676/680/686
0014.000		29303-156.20		FOLIE WAERMELEITEND T644/IC676		HEAT CONDUCTING FOIL T644/IC676
0015.000		29303-156.23		FOLIE WAERMELEITEND T568		HEAT CONDUCTING FOIL T568
				X = SIEHE GESONDERTE E-LISTE		X = SEE SEPARATE PARTS LIST
				WWW. = WAHLWEISE		WWW. = OPTIONAL

POS. NR. POS. NO.	SACHNUMMER PART NUMBER	BEZEICHNUNG DESCRIPTION
C 125	8668-203-023	ABBLOCK-C 0,1 UF -GR
C 202	8668-203-123	ABBLOCK-C 0,1 UF -GR
C 204	8668-203-023	ABBLOCK-C 0,1 UF -GR
C 205	8668-203-123	ABBLOCK-C 0,1 UF -GR
C 211	8668-203-123	ABBLOCK-C 0,1 UF -GR
C 332	8415-166-106	ELKO 1000UF 20% 16V
C 372	8415-166-106	ELKO 1000UF 20% 16V
C 377	8452-996-150	ELKO 2200UF 20% 25V
C 382	8668-203-023	ABBLOCK-C 0,1 UF -GR
C 411	8605-767-058	SSPN 390PF 20% 400V -GR
C 413	8452-996-187	ELKO 1000UF 20% 35V
C 421	8531-573-024	MKT 15 0,22 UF 20% 250V
C 441	8452-996-187	ELKO 1000UF 20% 35V
C 461	8452-996-187	ELKO 1000UF 20% 35V
C 567	8515-721-246	MKP10/4 0,68 UF 5% 250V
C 568	8515-911-416	KF 19 0,02 UF 5% 400V
C 569	8515-911-714	FOKO FKP1 0,013UF 3,5% 16
C 576	8525-040-819	KF 24 0,33 UF 10% 250V
C 578	8525-040-819	KF 24 0,33 UF 10% 250V
C 596	8426-098-061	ELKO 4,7UF 350V
C 598	8452-027-335	ELKO 29/V 22UF 350V
C 601	△ 8511-793-020	MP 3 0,1 UF 20% 250VW RM
C 602	△ 8511-793-020	MP 3 0,1 UF 20% 250VW RM
C 603	△ 8660-098-234	SI-KERKO B-SS 1000PF 20%
C 604	△ 8660-098-234	SI-KERKO B-SS 1000PF 20%

POS. NR. POS. NO.	SACHNUMMER PART NUMBER	BEZEICHNUNG DESCRIPTION
C 609	8563-732-425	KF 25 0,1 UF 20% 250VW
C 621	8650-081-125	HV-KERKO 1000PF 20% 1KV
C 622	8650-081-125	HV-KERKO 1000PF 20% 1KV
C 623	8650-081-125	HV-KERKO 1000PF 20% 1KV
C 624	8650-081-125	HV-KERKO 1000PF 20% 1KV
C 632	8555-269-039	KT/MKT 5/6 3900PF 5%
C 646	8650-067-486	HV-KERKO 470PF 20% 2KV
C 647	8531-510-687	MKT 15 0,033UF 20% 630V
C 648	8515-911-605	FKP1 220PF 5% 2000V
C 664	8555-269-041	KT/MKT 5/6 4700PF 5%
C 666	△ 8660-098-234	SI-KERKO B-SS 1000PF 20%
C 671	8650-067-046	HV-KERKO 100PF 20% 1KV
C 677	8452-996-147	ELKO 1000UF 20% 25V
C 680	8515-911-038	FKP1 100PF 10% 1600V
C 682	8451-997-092	ELKO 25 100UF 250V
C 862	8668-203-023	ABBLOCK-C 0,1 UF -GR
C 865	8668-203-023	ABBLOCK-C 0,1 UF -GR
D 101	8309-720-091	Z DIODE 9,1 C 0,5W
D 131	8309-198-040	DIODE TYP4 BAT41
D 132	8309-215-045	DIODE 1N4148
D 142	8309-200-021	DIODE BAV21 ITT/ TFK
D 146	8309-215-045	DIODE 1N4148
D 147	8309-215-045	DIODE 1N4148

POS. NR. POS. NO.	SACHNUMMER PART NUMBER	BEZEICHNUNG DESCRIPTION
D 148	8309-215-045	DIODE 1N4148
D 168	8309-215-045	DIODE 1N4148
D 216	8309-215-045	DIODE 1N4148
D 217	8309-215-045	DIODE 1N4148
D 218	8309-215-045	DIODE 1N4148
D 219	8309-215-045	DIODE 1N4148
D 262	8309-198-040	DIODE TYP4 BAT41
D 267	8309-198-040	DIODE TYP4 BAT41
D 272	8309-198-040	DIODE TYP4 BAT41
D 282	8309-215-045	DIODE 1N4148
D 286	8309-215-045	DIODE 1N4148
D 287	8309-215-045	DIODE 1N4148
D 289	8309-215-045	DIODE 1N4148
D 338	8305-306-001	IC ZTK 33 B DPD ITT
D 354	8309-720-027	Z DIODE 2,7 C 0,5W
D 358	8309-720-027	Z DIODE 2,7 C 0,5W
D 411	△ 8309-210-138	DIODE 1N4936/1SR124-400
D 416	8309-210-138	DIODE 1N4936/1SR124-400
D 418	8309-720-048	Z DIODE 4,7 C 0,5W
D 462	8309-215-045	DIODE 1N4148
D 513	8309-215-045	DIODE 1N4148
D 521	8309-720-048	Z DIODE 4,7 C 0,5W
D 566	8309-720-331	Z DIODE 30 C 0,5W
D 568	△ 8309-210-144	DIODE BYW 76 TFK 03/BYV
D 572	8309-201-005	DIODE BA157
D 584	8309-200-021	DIODE BAV21 ITT/ TFK
D 585	8309-720-220	Z DIODE 22 C 0,5W
D 586	8309-720-112	Z DIODE 12 C 0,5W
D 587	8309-215-045	DIODE 1N4148
D 592	8309-200-021	DIODE BAV21 ITT/ TFK
D 596	8309-215-020	DIODE 1 N 4004 -GA
D 598	△ 8309-204-268	DIODE BYV 16 TFK/BYV 96E/
D 621	8309-215-127	DIODE 1 N 4007 -GA
D 622	8309-215-127	DIODE 1 N 4007 -GA
D 623	8309-215-127	DIODE 1 N 4007 -GA
D 624	8309-215-127	DIODE 1 N 4007 -GA
D 641	8309-518-023	DIODE BYS 21-45 SIE
D 647	8309-516-854	DIODE BYT 54 M
D 648	8309-516-854	DIODE BYT 54 M
D 653	8309-516-754	DIODE BYT53B TFK/ EGP10B
D 661	8309-516-754	DIODE BYT53B TFK/ EGP10B
D 671	△ 8309-820-420	DIODE MUR 420
D 682	△ 8309-517-178	DIODE BYW178 TEMIC/ FUF5
D 811	8309-215-045	DIODE 1N4148
D 812	8309-215-045	DIODE 1N4148
D 813	8309-215-045	DIODE 1N4148
D 814	8309-215-045	DIODE 1N4148
D 816	8309-215-045	DIODE 1N4148
D 834	8309-215-045	DIODE 1N4148
D 836	8309-215-045	DIODE 1N4148
D 838	8309-215-045	DIODE 1N4148
D 934	8309-198-040	DIODE TYP4 BAT41
F 110	29303-117.04	VERZOEGERUNGSLEITUNG/ DELAY LINE
F 118	8140-535-211	SPULE 7X7 211/COIL
F 120	8140-601-600	FILTER SFB 4595 TDK
F 212	8382-336-270	QUARZ 27 MHZ
F 821	8602-341-085	CER.RES.85 4,00 MG
F 861	8140-540-104	EMIFIL 0,1 UF
IC 130	8305-125-103	IC STV2102B SGS
IC 210	8305-303-624	IC SAA5254P/E PHI
IC 260	8305-181-053	IC 74 HC 4053 N TID/PHI
IC 325	8305-367-245	IC TDA 7245 A SGS
IC 365	8305-367-245	IC TDA 7245 A SGS
IC 430	8305-338-174	IC TDA 8174 W
IC 440	8305-334-950	IC TDA4951-B
IC 631	8305-354-605	IC TDA 4605/3
IC 676	8305-204-317	IC LM 317 T NSC/MOT/

POS. NR. POS. NO.	SACHNUMMER PART NUMBER	BEZEICHNUNG DESCRIPTION
IC 680	8305-205-703	IC MC 7805 CT
IC 686	8305-205-703	IC MC 7805 CT
IC 820	8305-210-064	IC MC 33164 P-5RP
IC 847	8305-602-405	IC X 24 C 04 XICOR
IC 910	8305-362-124	IC TEA 2124
L 113	8140-526-451	DR AX 0411-GA 8,2UH
L 204	8104-982-014	DAEMPfungSPERLE/ DAMPING BEAD
L 212	8140-526-437	DR ST 0309-GRP 3,3UH
L 336	8140-505-247	DR A AX-GA 8,2UH
L 337	8140-505-075	DR A AX-GA 120UH
L 567	09246-846.54	SPULE BRUECKE (110) 1,3MH COIL BRIDGE
L 569	09245-405.08	O/W AUSKOPPELSPULE/COIL
L 568	8104-982-056	FERRITPERLE HF 70 BTL/ FERRITE BEAD
L 575	09240-110.51	DROSSEL 2,2 MH/CHOKO COIL
L 573	29203-124.95	LINEARITÄTSREGLER/ LINEARITY CONTROL
L 570	8104-982-056	FERRITPERLE HF 70 BTL/ FERRITE BEAD
L 577	8140-526-310	DR AX 0411-GA 10UH
L 601	△ 29500-812.97	FUNKENTSTOERDROSSEL/ INTERFERENCE SUPPRESSION COIL
L 648	8104-982-057	FERRITPERLE-GA 3,6UH/
L 653	8104-982-058	FERRITPERLE-GA 1,7UH/ FERRITE BEAD
L 671	8104-982-014	DAEMPfungSPERLE/ DAMPING BEAD
L 677	8140-525-969	DR AX 0411-GA 22UH
L 682	8104-982-057	FERRITPERLE-GA 3,6UH/ FERRITE BEAD
L 687	8104-982-014	DAEMPfungSPERLE/ DAMPING BEAD
Q 161	8602-099-503	CER.SCHWINGER CSB 503 F12
Q 171	8382-121-044	QUARZ 4,433619 MHZ
R 102	△ 8701-121-021	KSW SI B 6,8 OHM 5%
R 119	8790-050-017	ESTR.SK10-A 220 OHM LIN
R 178	8790-250-051	ESTR.PPK10-A 10 KOHM LIN
R 337	△ 8705-370-134	MOW 0922 15 KOHM 5%
R 376	△ 8732-292-411	DRW 4 2,7 OHM 10% KP292-0
R 401	8796-103-167	ESTR P6A 220 KOHM LIN N6
R 412	△ 8700-252-017	KSW NE 0414 4,7 OHM LCA
R 421	△ 8701-118-009	KSW SI B 2,2 OHM 5%
R 423	8796-103-135	ESTR P6A 1 KOHM LIN N6 P
R 431	8796-103-167	ESTR P6A 220 KOHM LIN N6
R 437	△ 8700-229-049	KSW NB 0207 100 OHM 5%
R 441	△ 8700-329-009	KSW NE 0207 2,2 OHM DRA
R 448	8773-297-040	ESTR.P 2,2 KOHM LIN PHI
R 462	8796-103-135	ESTR P6A 1 KOHM LIN N6 P
R 468	8796-103-164	ESTR P6A 100 KOHM LIN N6
R 563	△ 8705-329-033	MOW 0411 27 OHM 5%
R 567	△ 8766-327-009	MSW 0207 2,2 OHM 5% TK100
R 569	△ 8701-230-817	NKS 3 4,7 OHM 5% ROE
R 572	△ 8700-121-297	KSW 0207 10 KOHM 5%
R 573	△ 8705-221-271	MOW 0411 820 OHM 10% SXA
R 577	△ 8705-321-221	MOW 0411 6,8 OHM 10% SXS
R 586	△ 8700-329-083	KSW NB 0207 2,7 KOHM 5%
R 591	△ 8735-003-201	DRW 0,75W 1 OHM 10% BWF23
R 598	△ 8705-221-225	MOW 0411 10 OHM 5% SXA
R 599	△ 8705-321-221	MOW 0411 6,8 OHM 10% SXS
R 600	△ 8765-049-157	MSW 0414 3,3 MOHM VDE B
R 609	△ 8311-200-010	PTC #1 DUO
R 627	△ 8766-349-161	MSW SI 0414 4,7 MOHM 5%

POS. NR. POS. NO.	SACHNUMMER PART NUMBER	BEZEICHNUNG DESCRIPTION
R 633	△ 8766-357-115	MSW 0414 56 KOHM 5% VVV.0
R 646	△ 8705-369-301	MOW 0617 15 KOHM 10%
R 647	△ 8705-369-301	MOW 0617 15 KOHM 10%
R 654	8790-050-037	ESTR.SK10-A 1,5 KOHM LIN
R 682	△ 8705-329-321	MOW 0411 100 KOHM 10%
SI 376	△ 8315-618-200	LOET-SI.-GR 1 A/T
SI 563	△ 8315-612-027	LOET-SI.-GR 315 MA/T
SI 601	△ 8315-621-027	LOET-SI.-GR 2,5 A/T
SI 624	△ 8315-618-225	LOET-SI.-GR 1,25 A/T
SI 671	△ 8315-620-225	LOET-SI.-GR 2 A/T
T 101	8303-269-338	TRANS.BC 338
T 103	8303-207-548	TRANS BC548C
T 127	8303-207-548	TRANS BC548C
T 139	8303-205-548	TRANS BC548B
T 147	8303-201-558	TRANS.BC 558
T 163	8303-201-558	TRANS.BC 558
T 168	8303-201-548	TRANS BC548
T 282	8303-201-558	TRANS.BC 558
T 284	8303-205-548	TRANS BC548B
T 286	8303-205-548	TRANS BC548B
T 294	8303-205-548	TRANS BC548B
T 356	8303-201-558	TRANS.BC 558
T 358	8303-283-338	TRANS.BC 338-40
T 513	8303-285-637	TRANS.BC 637
T 568	8302-631-432	TRANS 2SD1432 TOS
T 583	8303-205-548	TRANS BC548B
T 593	8303-401-299	TRANS.S 298 T TFK/PBF 259
T 644	8302-269-089	TRANS.BUZ 90
T 835	8303-205-548	TRANS BC548B
T 926	8303-201-558	TRANS.BC 558
T 435	8302-210-441	TRANS.BD 441 SGS
T 436	8302-210-442	TRANS.BD 442 SGS
TR 526	△ 29201-029.69	TRAFO DIODEN SPLIT KPL./ DIODE SPLIT TRANSFORMER CPL
TR 563	△ 09246-864.04	TREIBERTRAFO/ DRIVE TRANSFORMER
TR 651	△ 29201-334.97	TRAFO SPERRWANDLER KPL./ B.O.-TYPE CONVERTER TRANSFORMER CPL.
Es gelten die Vorschriften und Sicherheitshinweise gemäß dem Service Manual "Sicherheit", Sach-Nummer 72010-800.00, sowie zusätzlich die eventuell abweichenden, landesspezifischen Vorschriften!		



The regulations and safety instructions shall be valid as provided by the "Safety" Service Manual, part number 72010-800.00, as well as the respective national deviations.

GRUNDIG Ersatzteilliste Spare Parts List



D Btx * 32700 #

4 / 96

GREENVILLE 7002 TEXT GREENVILLE 7002/8 TEXT

SACH-NR. / PART NO.: 9.21536-0175 BESTELL-NR. / ORDER NO.: G.CD 8475 COSMOS-SCHWARZ/COSMOS BLACK
SACH-NR. / PART NO.: 9.21536-0275 BESTELL-NR. / ORDER NO.: G.CD 8575 COSMOS-SCHWARZ/COSMOS BLACK

POS. NR. POS. NO.	ABB. FIG.	SACHNUMMER PART NUMBER	ANZ. QUA.	BEZEICHNUNG ①	DESCRIPTION ②
0001.000		29635-134.08		GEHAEUSEVORDERTEIL KPL.	CABINET FRONT CPL.
0001.100		29602-603.51		GRUNDIG-EMBLEM	GRUNDIG EMBLEM
0001.200		29608-864.01	4	SOCKELEINLAGE	BASE INSERT
0001.300		29633-410.01	2	GITTER	GRILLE
0003.000		29633-417.01		IR-FENSTER	IR WINDOW
0006.000		29628-548.01	2	CHASSISBEFESTIGUNG	CHASSIS FIXING
0008.000		19136-008.97	2	LAUTSPRECHER	LOUDSPEAKER
0009.000		29631-707.01		RUECKWAND	REAR PANEL
0010.000		29618-125.04		AUFKLEBER GERAETETYP .01	ADHESIVE LABEL;STICKER .01
0010.000		29618-126.04		AUFKLEBER GERAETETYP .02	ADHESIVE LABEL;STICKER .02
		29656-003.65		MONTAGE-ZUBEHOER F.BILDROHR KEIN E-TEIL	MOUNTING ACCESSORIES FOR CRT NO SPARE PART
0021.000		29607-219.01	8	SPULENHAKEN	COIL HOOK
0024.000	△	09246-191.75		ENTMAGNETISIERUNGSSPULE	DEGAUSSING COIL
0025.000	△	8300-030-435		BILDR. A 66 EAK 71X01 WW.	CRT A 66 EAK 71X01 OPT
0026.000	△	29201-360.02		ANODENKAPPE MIT HOCHSPG.-KABEL	C.R.T. SOCKET
0030.000		29501-082.40		BEDIENEINHEIT	CONTROL UNIT
0030.100		29303-168.17		CINCHBUCHSE 3-FACH	CINCH SOCKET 3-FOLD
0030.200		29303-390.41		KOPFHUERBUCHSE	EAR PHONE SOCKET
0030.600	△	29703-291.71		NETZSCHALTER ECO O.W.	POWER SWITCH ECO
0030.700		29703-357.01	4	TASTSCHALTER	TACT SWITCH
0034.000		29501-591.06		TASTENSATZ	KEY SET
0046.000		29633-437.01		ABDECKUNG	COVER
0047.000		29633-435.11		TASTENKNOPF NETZ	KEY BUTTON MAINS
0048.000	△	8290-991-316		NETZKABEL KPL	POWER CABLE CPL GWN9.22
0049.000		29642-061.11		TELEPILOT TP 900	REMOTE CONTROL TP 900
		29305-122.05	X	BILDROHRPLATTE BM	PICTURE TUBE BOARD
		21536-941.01		BEDIENUNGSANLEITUNG .01	INSTRUCKTION MANUAL .01
		21536-941.02		BEDIENUNGSANLEITUNG .02	INSTRUCKTION MANUAL .02
		29701-094.18	X	CHASSIS-FS-STEREO .01 CUC 6330 KEIN E-TEIL	CHASSIS TV STEREO .01 CUC 6330 NO SPARE PART
		29701-094.19	X	CHASSIS-FS-STEREO .02 CUC 6330 KEIN E-TEIL	CHASSIS TV STEREO .02 CUC 6330 NO SPARE PART
				X = SIEHE GESONDERTE E-LISTE WW. = WAHLWEISE	X = SEE SEPARATE PARTS LIST WW. = OPTIONAL

POS. NR. POS. NO.	SACHNUMMER PART NUMBER	BEZEICHNUNG DESCRIPTION
D 81501	8309-215-045	DIODE 1N4148
IC 84001	8305-367-530	IC TFMS 5300
R 60000	8765-049-157	MSW 0414 3,3 MOHM VDE B
T 81501	8303-295-875	TRANS.BC 875/877/879 SIE
T 81502	8303-205-548	TRANS BC548B
T 81506	8303-205-548	TRANS BC548B

POS. NR. POS. NO.	SACHNUMMER PART NUMBER	BEZEICHNUNG DESCRIPTION
----------------------	---------------------------	----------------------------

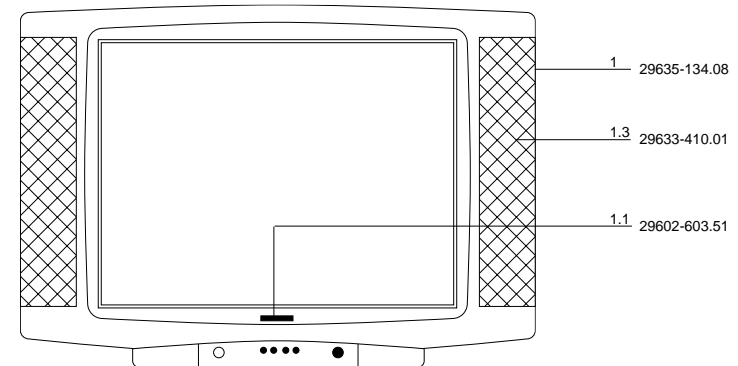

Es gelten die Vorschriften und Sicherheitshinweise gemäß dem Service Manual "Sicherheit", Sach-Nummer 72010-800.00, sowie zusätzlich die eventuell abweichenden, landesspezifischen Vorschriften!



The regulations and safety instructions shall be valid as provided by the "Safety" Service Manual, part number 72010-800.00, as well as the respective national deviations.

GRUNDIGErsatzteilliste
Spare Parts List

D Btx * 32700 #

4 / 96

ST 70-725/8 TEXT

ST 70-725/8 FT/GB

SACH-NR. / PART NO.: 9.21506-0269 BESTELL-NR. / ORDER NO.: G.CD 2669 ANTHRAZIT BLUE
SACH-NR. / PART NO.: 9.21506-6469 BESTELL-NR. / ORDER NO.: G.CD 2869 GB ANTHRAZIT BLUE

POS. NR. POS. NO.	ABB. FIG.	SACHNUMMER PART NUMBER	ANZ. QUA.	BEZEICHNUNG D	DESCRIPTION GB
0001.000		29635-127.03		GEHAEUSEVORDERTEIL KPL	CABINET FRONT, CPL.
0001.100		29602-603.51		GRUNDIG-EMBLEM	GRUNDIG EMBLEM
0001.200		29633-372.01	2	GITTER	GRILLE
0001.300		29633-374.01		INFRA-FENSTER	INFRA-WINDOW
0001.400		29633-403.52		ABDECKUNG DRUCK KPL	COVER PRESSURE CPL.
0006.000		19126-024.97	2	LAUTSPRECHER	LOUDSPEAKER
0009.000		29631-699.01		GEHAEUSERUECKTEIL	CABINET BACK
WW.		29631-699.04		GEHAEUSERUECKTEIL	CABINET BACK
0012.000		29628-548.01	2	CHASSISBEFESTIGUNG	CHASSIS FIXING
		29656-003.65		MONTAGE-ZUBEHOER F.BILDROHR KEIN E-TEIL	MOUNTING ACCESSORIES FOR CRT NO SPARE PART
0021.000		29607-219.01	8	SPULENHAKEN	COIL HOOK
0024.000	△	09246-191.75		ENTMAGNETISIERUNGSSPULE	DEGAUSSING COIL
0025.000	△	8300-030-435		BILDR. A 66 EAK 71X01 WW.	CRT A 66 EAK 71X01 OPT
0026.000	△	29201-360.02		ANODENKAPPE MIT HOCHSPG.-KABEL	C.R.T. SOCKET
0030.000		29501-082.11		BEDIENEINHEIT	CONTROL UNIT
0030.100		29303-168.26		CINCHBUCHSE 3-FACH	CINCH SOCKET 3-FOLD
0030.200		29303-390.41		KOPFHOERERBUCHSE	EAR PHONE SOCKET
0030.300		29703-357.11	4	TASTSCHALTER	KEY SWITCH
0030.400		29501-611.51		TASTENSATZ	KEYS SET
0041.000		29633-426.01		BUCHSENABDECKUNG	SOCKET COVER
0043.000		29501-613.51		TASTENKNOPF NETZ	KEY BUTTON
0044.000	△	8290-991-316		NETZKABEL KPL. 02	POWER CABLE CPL GWN9.22 .02
0044.000	△	8290-991-386		NETZKABEL KPL. 64	POWER CABLE CPL GWN9.22 .64
0045.000		29642-059.06		TELEPILOT TP 720	REMOTE CONTROL TP 720
		29305-122.05	X	BILDROHRPLATTE BM	PICTURE TUBE BOARD
		21506-941.01		BEDIENUNGSANLEITUNG .02	INSTRUCTION MANUAL .02
		21506-941.02		BEDIENUNGSANLEITUNG .64	INSTRUCTION MANUAL .64
		29701-094.05	X	CHASSIS-FS-STEREO .02 CUC 6330 KEIN E-TEIL	CHSSS TV STEREO .02 CUC 6330 NO SPARE PART
		29701-094.10	X	CHASSIS-FS-STEREO .64 CUC 6330 KEIN E-TEIL	CHSSS TV STEREO .64 CUC 6330 NO SPARE PART
				X = SIEHE GESONDERTE E-LISTE WW. = WAHLWEISE	X = SEE SEPARATE PARTS LIST WW. = OPTIONAL

POS. NR. POS. NO.	SACHNUMMER PART NUMBER	BEZEICHNUNG DESCRIPTION	POS. NR. POS. NO.	SACHNUMMER PART NUMBER	BEZEICHNUNG DESCRIPTION
C 41504	8668-203-023	ABBLOCK-C 0,1 UF -GR			
D 857	8309-944-601	LE DIODE TLHR 4601 TFK			
IC 84001	8305-367-530	IC TFMS 5300			

ST 70-725/8 TEXT

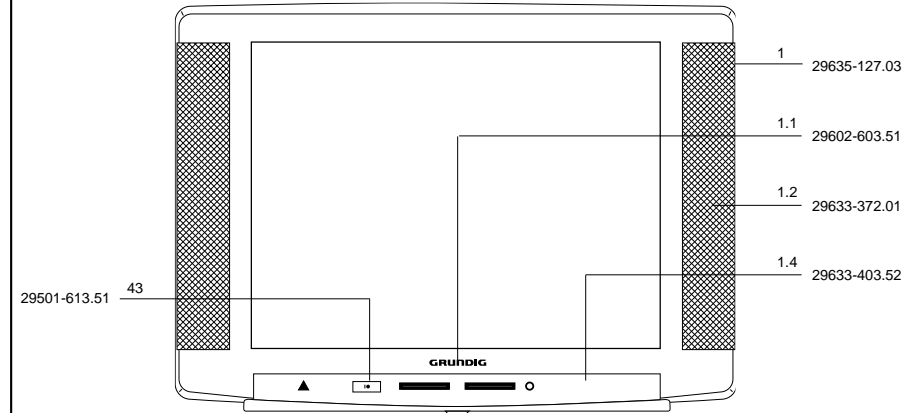

ST 70-725/8 FT/GB

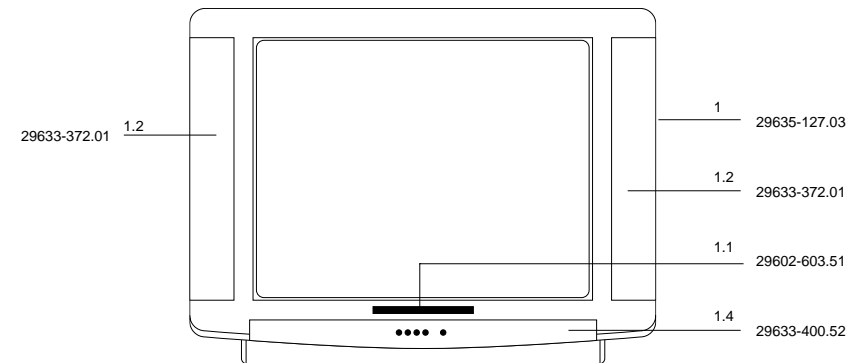

Es gelten die Vorschriften und Sicherheitshinweise gemäß dem Service Manual "Sicherheit", Sach-Nummer 72010-800.00, sowie zusätzlich die eventuell abweichenden, landesspezifischen Vorschriften!



The regulations and safety instructions shall be valid as provided by the "Safety" Service Manual, part number 72010-800.00, as well as the respective national deviations.

GRUNDIGErsatzteilliste
Spare Parts List

D Btx * 32700 #

4 / 96

ST 63-725/8 TEXT
ST 63-725/8 FT/GBSACH-NR. / PART NO.: 9.21507-0269 BESTELL-NR. / ORDER NO.: G.CD 2769 ANTHRAZIT BLUE
SACH-NR. / PART NO.: 9.21507-6469 BESTELL-NR. / ORDER NO.: G.CD 2969 GB ANTHRAZIT BLUE

POS. NR. POS. NO.	ABB. FIG.	SACHNUMMER PART NUMBER	ANZ. QUA.	BEZEICHNUNG D	DESCRIPTION GB
0001.000		29635-125.03		GEHAEUSEVORDERTEIL KPL.	CABINET FRONT CPL.
0001.100		29602-603.51		GRUNDIG-EMBLEM	GRUNDIG EMBLEM
0001.200		29633-400.52		ABDECKUNG DRUCK KPL.	COVER CPL.
0001.300		29633-402.01		INFRA-FENSTER	INFRA WINDOW
0001.400		29633-379.01	2	GITTER	GRILLE
0005.000		19126-024.97	2	LAUTSPRECHER	LOUDSPEAKER
0007.000		29628-548.01	2	CHASSISBEFESTIGUNG	CHASSIS FIXING
0008.000		29501-611.51		TASTENSATZ	KEYS SET
0010.000		29631-739.01		RUECKWAND	REAR PANEL
		29656-003.64		MONTAGE-ZUBEHOER F.BILDROHR	MOUNTING ACCESSORIES FOR CRT
		00000-000.00		KEIN E-TEIL	NO SPARE PART
0021.000		29607-219.01	8	SPULENHAKEN	COIL HOOK
0024.000	△	09246-208.75		ENTMAGNETISIERUNGSSPULE	DEGAUSSING COIL
0025.000	△	8300-020-401		BILDR. A 59 EAK 01X01 WW.	CRT A 59 EAK 01X01 OPT
0026.000	△	29201-360.02		ANODENKAPPE MIT HOCHSPG.-KABEL	C.R.T. SOCKET
0030.000		29501-082.11		BEDIENEINHEIT	CONTROL UNIT
0030.100		29303-168.26		CINCHBUCHSE 3-FACH	CINCH SOCKET 3-FOLD
0030.200		29303-390.41		KOPFHOERERBUCHSE	EAR PHONE SOCKET
0030.300		29703-357.11	4	TASTSCHALTER	KEY SWITCH
0041.000		29633-426.01		BUCHSENABDECKUNG	SOCKET COVER
0042.000		29501-613.51		TASTENKNOPF NETZ	KEY BUTTON MAINS
0044.000	△	8290-991-316		NETZKABEL KPL. 02	POWER CABLE CPL GWN9.22 02
0044.000	△	8290-991-386		NETZKABEL KPL. 64	POWER CABLE CPL GWN9.22 64
0045.000		29642-059.06		TELEPILOT TP 720	REMOTE CONTROL TP 720
		29305-122.05	X	BILDROHRPLATTE BM	PICTURE TUBE BOARD
		21506-941.01		BEDIENUNGSANLEITUNG 02	INSTRUCTION MANUAL 02
		21506-941.02		BEDIENUNGSANLEITUNG 64	INSTRUCTION MANUAL 64
		29701-094.06	X	CHASSIS-FS-STEREO 02 CUC 6330	CHASSIS TV STEREO 02 CUC 6330
				KEIN E-TEIL	NO SPARE PART
		29701-094.11	X	CHASSIS-FS-STEREO 64 CUC 6330 GB	CHASSIS TV STEREO 64 CUC 6330 GB
				KEIN E-TEIL	NO SPARE PART
				X = SIEHE GESONDERTE E-LISTE	X = SEE SEPARATE PARTS LIST
C 41504		8668-203-023		ABBLOCK-C 0,1 UF -GR	BLOCKING CAPACITOR 0,1 UF -GR
D 805		8309-944-601		LE DIODE TLHR 4601 TFK	LE DIODE TLHR 4601 TFK
D 816		8309-944-601		LE DIODE TLHR 4601 TFK	LE DIODE TLHR 4601 TFK
IC 84001		8305-367-530		IC TFMS 5300	IC TFMS 5300

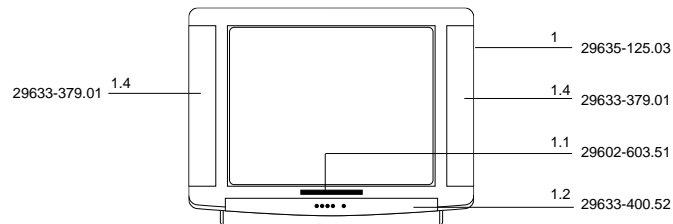
**GRUNDIG**Ersatzteilliste
Spare Parts List

D Btx * 32700 #

4 / 96

ST 70-720/8 TEXT

SACH-NR. / PART NO.: 9.21403-0275
BESTELLI-NR. / ORDER NO.: G.CC 4475 COSMOS-SCHWARZ/COSMOS BLACK

POS. NR. POS. NO.	ABB. FIG.	SACHNUMMER PART NUMBER	ANZ. QUA.	BEZEICHNUNG D	DESCRIPTION GB
0001.000		29625-709.01		GEHAEUSEVORDERTEIL OFB	CABINET FRONT
0001.100		29602-603.51		GRUNDIG-EMBLEM	GRUNDIG EMBLEM
0001.200		29633-513.52		ABDECKUNG KPL	COVER CPL.
0001.300		29608-864.01	4	SOCKELEINLAGE	BASE INSERT
0005.000		29628-548.01	2	CHASSISBEFESTIGUNG	CHASSIS FIXING
0006.000		19126-024.97	2	LAUTSPRECHER	LOUDSPEAKER
0007.000		29633-558.01		BUCHSENABDECKUNG	SOCKET COVER
0009.000		29631-887.85		GEHAEUSERUECKTEIL	REAR PANEL
0010.000		29618-083.14		AUFKLEBER TYP	ADHESIVE LABEL;STICKER
		29656-003.65		MONTAGE-ZUBEHOER F.BILDROHR	MOUNTING ACCESSORIES FOR CRT
				KEIN E-TEIL	NO SPARE PART
0021.000		29607-219.01	8	SPULENHAKEN	COIL HOOK
0024.000	△	09246-191.75		ENTMAGNETISIERUNGSSPULE	DEGAUSSING COIL
0025.000	△	8300-030-435		BILDR. A 66 EAK 71X01 WW.	CRT A 66 EAK 71X01 OPT
0026.000	△	29201-360.02		ANODENKAPPE MIT HOCHSPG.-KABEL	C.R.T. SOCKET
0030.000		29501-082.04		BEDIENEINHEIT	CONTROL UNIT
0030.100		29303-168.17		CINCHBUCHSE 3-FACH	CINCH SOCKET 3 FOLD
0030.200		29303-390.41		KOPFHOERERBUCHSE	EAR PHONE SOCKET
0030.300		29703-357.11	4	TASTSCHALTER BEDIEN-TEIL	KEY SWITCH
0030.400		29501-622.01		TASTENSATZ	KEYS SET
0030.500		29501-638.01		VERLAENGERUNG	EXTENSION
0032.000	△	8290-991-316		NETZKABEL KPL	POWER CABLE CPL GWN9.22
0034.000		29642-059.06		TELEPILOT TP 720	REMOTE CONTROL TP 720
		29305-122.05	X	BILDROHRPLATTE BM	PICTURE TUBE BOARD
		21403-941.02		BEDIENUNGSANLEITUNG	INSTRUCTION MANUAL
		29701-094.05	X	CHASSIS-FS-STEREO CUC 6330	CHASSIS TV STEREO CUC 6330
				KEIN E-TEIL	NO SPARE PART
				X = SIEHE GESONDERTE E-LISTE	X = SEE SEPARATE PARTS LIST
C 41504		8668-203-023		ABBLOCK-C 0,1 UF -GR	BLOCKING CAPACITOR 0,1 UF -GR
D 805		8309-944-601		LE DIODE TLHR 4601 TFK	LE DIODE TLHR 4601 TFK
D 816		8309-944-601		LE DIODE TLHR 4601 TFK	LE DIODE TLHR 4601 TFK
IC 84001		8305-367-530		IC TFMS 5300	IC TFMS 5300

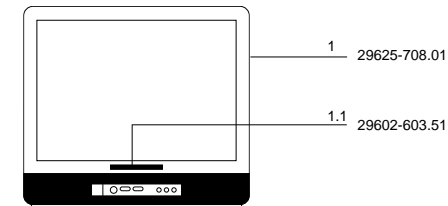

GRUNDIGErsatzteilliste
Spare Parts List

D Btx * 32700 #

4 / 96

ST 63-720/8 TEXT

SACH-NR. / PART NO.: 9.21404-0275
BESTELLI-NR. / ORDER NO.: G.CC 5075 COSMOS-SCHWARZ/COSMOS BLACK

POS. NR. POS. NO.	ABB. FIG.	SACHNUMMER PART NUMBER	ANZ. QUA.	BEZEICHNUNG D	DESCRIPTION GB
0001.000		29625-708.01		GEHAEUSEVORDERTEIL OFB	CABINET FRONT
0001.100		29602-603.51		GRUNDIG-EMBLEM	GRUNDIG EMBLEM
0001.200		29633-513.53		ABDECKUNG KPL	COVER CPL.
0005.000		29628-548.01	2	CHASSISBEFESTIGUNG	CHASSIS FIXING
0006.000		19126-030.97	2	LAUTSPRECHER	SPEAKER
0007.000		29633-558.01		BUCHSENABDECKUNG	SOCKET COVER
0009.000		29631-891.85		GEHAEUSERUECKTEIL	REAR PANEL
0010.000		29618-084.14		AUFKLEBER TYP	ADHESIVE LABEL;STICKER
		29656-003.64		MONTAGE-ZUBEHOER F. BILDROHR KEIN E-TEIL	MOUNTING ACCESSORIES FOR CRT NO SPARE PART
0021.000		29607-219.01	8	SPULENHAKEN	COIL HOOK
0024.000	△	09246-208.75		ENTMAGNETISIERUNGSSPULE	DEGAUSSING COIL
0025.000	△	8300-020-401		BILDR. A 59 EAK 01X01 WW.	CRT A 59 EAK 01X01 OPT
0026.000	△	29201-360.02		ANODENKAPPE MIT HOCHSPG.-KABEL	C.R.T. SOCKET
0030.000		29501-082.04		BEDIENEINHEIT	CONTROL UNIT
0030.100		29303-168.17		CINCHBUCHSE 3-FACH	CINCH SOCKET 3 FOLD
0030.200		29303-390.41		KOPFHOERERBUCHSE	EAR PHONE SOCKET
0030.300		29703-357.11	4	TASTSCHALTER	KEY SWITCH
0030.400		29501-622.01		TASTENSATZ	KEYS SET
0030.500		29501-638.01		VERLAENGERUNG	EXTENSION
0032.000	△	8290-991-316		NETZKABEL KPL.	POWER CABLE CPL GWN9.22
0034.000		29642-059.06		TELEPILOT TP 720	REMOTE CONTROL TP 720
		29305-122.05	X	BILDROHRPLATTE BM	PICTURE TUBE BOARD
		21403-941.02		BEDIENUNGSANLEITUNG	INSTRUCTION MANUAL
		29701-094.06	X	CHASSIS-FS-STEREO CUC 6330 KEIN E-TEIL	CHASSIS TV STEREO CIC 6330 NO SPARE PART
				X = SIEHE GESONDERTE E-LISTE	X = SEE SEPARATE PARTS LIST
C 41504		8668-203-023		ABBLOCK-C 0,1 UF -GR	BLOCKING CAPACITOR 0,1 UF -GR
D 805		8309-944-601		LE DIODE TLHR 4601 TFK	LE DIODE TLHR 4601 TFK
D 816		8309-944-601		LE DIODE TLHR 4601 TFK	LE DIODE TLHR 4601 TFK
IC 84001		8305-367-530		IC TFMS 5300	IC TFMS 5300

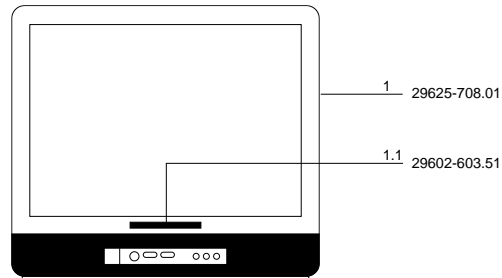
**GRUNDIG**Ersatzteilliste
Spare Parts List

D Btx * 32700 #

4 / 96

XS 63/81

SACH-NR. / PART NO.: 9.21422-0275
BESTELL-NR. / ORDER NO.: G.CC 5275 COSMOS-SCHWARZ/COSMOS BLACK

POS. NR. POS. NO.	ABB. FIG.	SACHNUMMER PART NUMBER	ANZ. QUA.	BEZEICHNUNG D	DESCRIPTION GB
0001.000		29625-631.04		GEHAEUSEVORDERTEIL OFB	CABINET FRONT
0001.100		29602-603.51		GRUNDIG-EMBLEM	GRUNDIG EMBLEM
0001.300		29633-238.01		ABDECKUNG DRUCK KPL	COVER
0001.500		29628-583.57	2	GITTER KPL	GRID, GRILLE
0005.000		19126-024.97	2	LAUTSPRECHER	LOUDSPEAKER
0006.000		29628-548.01	2	CHASSISBEFESTIGUNG	CHASSIS FIXING
0008.000		29631-831.85		GEHAEUSERUECKTEIL	REAR PANEL
0009.000		29618-096.14		AUFKLEBER TYP	ADHESIVE LABEL;STICKER
		29656-003.64		MONTAGE-ZUBEHOER F.BILDROHR KEIN E-TEIL	MOUNTING ACCESSORIES FOR CRT NO SPARE PART
0021.000		29607-219.01	8	SPULENHAKEN	COIL HOOK
0024.000	△	09246-208.75		ENTMAGNETISIERUNGSSPULE	DEGAUSSING COIL
0025.000	△	8300-020-401		BILDR. A 59 EAK 01X01 WW.	CRT A 59 EAK 01X01 OPT
0026.000	△	29201-360.02		ANODENKAPPE MIT HOCHSPG.-KABEL	C.R.T. SOCKET
0030.000		29501-082.12		BEDIENEINHEIT	CONTROL UNIT
0030.100		29303-390.63		KOPFHOERERBUCHSE	EAR PHONE SOCKET
0030.200		29501-512.01		TASTENSATZ	KEYS SET
0030.400	△	29703-291.21		NETZSCHALTER	POWER SWITCH
0030.600	△	29703-291.31		NETZSCHALTER	POWER SWITCH
0050.000	△	29703-357.01	4	TASTSCHALTER	TACT SWITCH
0052.000		8290-991-316		NETZKABEL KPL	POWER CABLE CPL GWN9.22
0053.000		29633-031.01		TASTENKNOPF NETZ	KEY KNOB
		29642-059.06		TELEPILOT TP 720	REMOTE CONTROL TP 720
		29305-122.05	X	BILDROHRPLATTE BM	PICTURE TUBE BOARD
		21422-941.01		BEDIENUNGSANLEITUNG	INSTRUCTION MANUAL
		29701-094.08	X	CHASSIS-FS-STEREO CUC 6330 KEIN E-TEIL	CHASSIS TV STEREO CUC 6330 NO SPARE PART
				X = SIEHE GESONDERTE E-LISTE WW. = WAHLWEISE	X = SEE SEPARATE PARTS LIST WWW. = OPTIONAL
C 41504		8668-203-023		ABBLOCK-C 0,1 UF -GR	BLOCKING CAPACITOR 0,1 UF -GR
D 85001		8309-944-601		LE DIODE TLHR 4601 TFK	LE DIODE TLHR 4601 TFK
IC 84001		8305-367-530		IC TFMS 5300	IC TFMS 5300
R 60000	△	8765-049-157		MSW 0414 3,3 MOHM VDE B	MSW 0414 3,3 MOHM VDE B

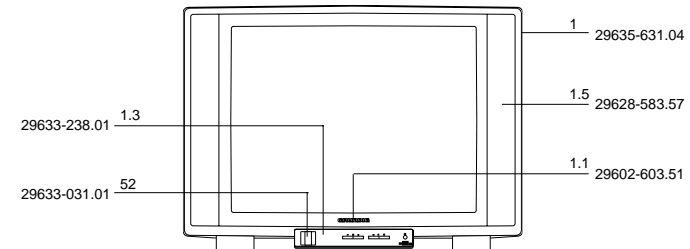

GRUNDIG Ersatzteilliste Spare Parts List



D Btx * 32700 #

4 / 96

XS 70/81

ST 70-728 TEXT

SACH-NR. / PART NO.: 9.21420-0275 BESTELL-NR. / ORDER NO.: G.CC 5175 COSMOS-SCHWARZ/COSMOS BLACK
SACH-NR. / PART NO.: 9.21420-2175 BESTELL-NR. / ORDER NO.: G.CE 1075 COSMOS-SCHWARZ/COSMOS BLACK

POS. NR. POS. NO.	ABB. FIG.	SACHNUMMER PART NUMBER	ANZ. QUA.	BEZEICHNUNG DESCRIPTION	DESCRIPTION
0001.000		29625-619.05		GEHAEUSEVORDERTEIL OFB	CABINET FRONT
0001.100		29602-603.51		GRUNDIG-EMBLEM	GRUNDIG EMBLEM
0001.300		29633-238.01		ABDECKUNG DRUCK KPL.	COVER PRESSURE CPL.
0001.500		29628-567.55	2	GITTER KPL.	GRILLE CPL.
0005.000		19126-024.97	2	LAUTSPRECHER	LOUDSPEAKER
0006.000		29628-548.01	2	CHASSISBEFESTIGUNG	CHASSIS FIXING
0008.000		29631-830.85		GEHAEUSERUECKTEIL	REAR PANEL
0009.000		29618-097.14		AUFKLEBER TYP .02	ADHESIVE LABEL;STICKER .02
0009.000		29618-097.04		AUFKLEBER TYP .21	ADHESIVE LABEL;STICKER .21
		29656-003.65		MONTAGE-ZUBEHOER F.BILDROHR KEIN E-TEIL	MOUNTING ACCESSORIES FOR CRT NO SPARE PART
0021.000		29607-219.01	8	SPULENHAKEN	COIL HOOK
0024.000	△	09246-191.75		ENTMAGNETISIERUNGSSPULE	DEGAUSSING COIL
0025.000	△	8300-030-435		BILDR. A 66 EAK 71X01 WW.	CRT A 66 EAK 71X01 OPT
0026.000	△	29201-360.02		ANODENKAPPE MIT HOCHSPG.-KABEL	C.R.T. SOCKET
0030.000		29501-082.12		BEDIENEINHEIT	CONTROL UNIT
0030.100		29303-390.63		KOPFHUERBUCHSE	EAR PHONE SOCKET
0030.200		29501-512.01		TASTENSATZ	KEYS SET
0030.300	△	29703-291.21		NETZSCHALTER	POWER SWITCH
WW.	△	29703-291.31		NETZSCHALTER	POWER SWITCH
0030.500		29703-357.01	4	TASTSCHALTER	TACT SWITCH
0050.000	△	8290-991-316		NETZKABEL KPL.	POWER CABLE CPL GWN9.22
0052.000		29633-031.01		TASTENKNOPF NETZ	KEY KNOB MAINS
0053.000		29642-059.06		TELEPILOT TP 720 .02	REMOTE CONTROL TP 720 .02
0053.000		29642-063.01		TELEPILOT TP 712 .21	REMOTE CONTROL TP 712 .21
		29305-122.05	X	BILDROHRPLATTE BM	PICTURE TUBE BOARD
		21420-941.02		BEDIENUNGSANLEITUNG .02	INSTRUCTION MANUAL .02
		21420-941.01		BEDIENUNGSANLEITUNG .21	INSTRUCTION MANUAL .21
		29701-094.07	X	CHASSIS-FS-STEREO .02 CUC 6330 KEIN E-TEIL	CHASSIS TV STEREO .02 CUC 6330 NO SPARE PART
		29701-094.03	X	CHASSIS-FS-STEREO .21 CUC 6330 KEIN E-TEIL	CHASSIS TV STEREO .21 CUC 6330 NO SPARE PART
				X = SIEHE GESONDERTE E-LISTE WW. = WAHLWEISE	X = SEE SEPARATE PARTS LIST WW. = OPTIONAL

POS. NR. POS. NO.	SACHNUMMER PART NUMBER	BEZEICHNUNG DESCRIPTION
C 41504	8668-203-023	ABBLOCK-C 0,1 UF -GR
D 85001	8309-944-601	LE DIODE TLHR 4601 TFK
IC 84001	8305-367-530	IC TFMS 5300
R 60000	△ 8765-049-157	MSW 0414 3,3 MOHM VDE B

POS. NR. POS. NO.	SACHNUMMER PART NUMBER	BEZEICHNUNG DESCRIPTION
----------------------	---------------------------	----------------------------

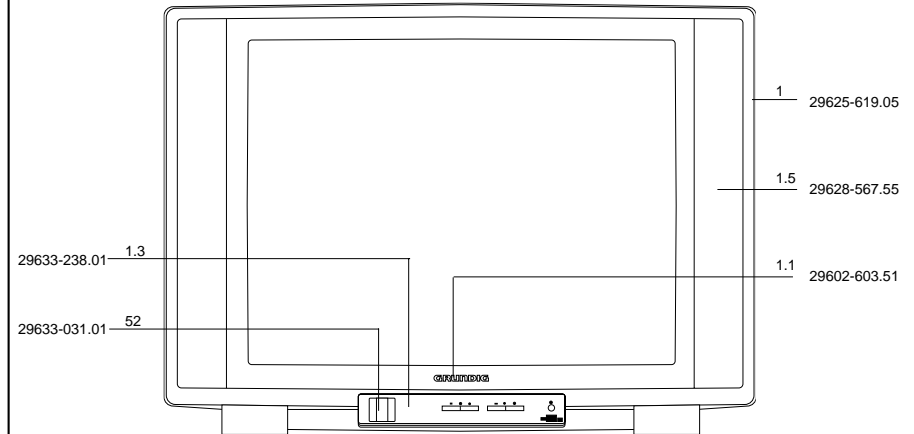

Es gelten die Vorschriften und Sicherheitshinweise gemäß dem Service Manual "Sicherheit", Sach-Nummer 72010-800.00, sowie zusätzlich die eventuell abweichenden, landesspezifischen Vorschriften!



The regulations and safety instructions shall be valid as provided by the "Safety" Service Manual, part number 72010-800.00, as well as the respective national deviations.

GRUNDIGErsatzteilliste
Spare Parts List

D Btx * 32700 #

4 / 96

SE 7277 TEXT

SACH-NR. / PART NO.: 9.21542-0124 BESTELL-NR. / ORDER NO.: G.CE 0424 NBF.
SACH-NR. / PART NO.: 9.21542-0192 BESTELL-NR. / ORDER NO.: G.CE 0492 DKL. MET.

POS. NR. POS. NO.	ABB. FIG.	SACHNUMMER PART NUMBER	ANZ. QUA.	BEZEICHNUNG D	DESCRIPTION GB
0001.000		29625-655.04		GEHAEUSE LACKIERT .24	HOUSING LACQUERED .24
0001.000		29625-655.03		GEHAEUSE LACKIERT .92	HOUSING LACQUERED .92
0001.100		29608-864.01	4	SOCKELEINLAGE	BASE INSERT
0001.200		27041-217.01		DRUCKSCHNAPPER	PRESSURE SNAPPER
0001.300		29628-715.51		GITTER KPL LINKS	GRILLE CPL., LEFT
0001.400		29628-715.52		GITTER KPL RECHTS	GRILLE CPL., RIGHT
0001.500		29633-248.01		INFRA-FENSTER DRUCK KPL.	INFRA WINDOW PRINT CPL.
0001.600		29633-285.01		KLAPPE DRUCK KPL.	FLAP PRESSURE CPL.
0002.000		29625-673.02		BLENDE KPL. .24	MASK CPL. .24
0002.000		29625-662.01		BLENDE KPL. .92	MASK CPL. .92
0002.100		29602-603.51		GRUNDIG-EMBLEM	GRUNDIG EMBLEM
0006.000		29628-548.01	2	CHASSISBEFESTIGUNG	CHASSIS FIXING
0008.000		19136-008.97	2	LAUTSPRECHER	LOUDSPEAKER
0009.000		29631-707.03		RUECKWAND	REAR PANEL
0010.000		29618-192.04		AUFKLEBER TYPE	ADHESIVE LABEL;STICKER
		29656-003.67		MONTAGEZUBEHOER F.BILDROHR KEIN E-TEIL	MOUNTING ACCESSORIES F.CRT NO SPARE PART
0021.000		29607-296.01	4	SPULENKLAMMER	COIL CLAMP
0024.000	△	09246-191.75		ENTMAGNETISIERUNGSSPULE	DEGAUSSING COIL
0025.000	△	8300-068-202		BILDR.A68ESF202X11	PICT.TUBE A68ESF202X11
0026.000	△	29201-360.02		ANODENKAPPE MIT HOCHSPG.-KABEL	C.R.T. SOCKET
		29304-019.95		MOEVEN-ENTZERRUNGSPLATTE KEIN E-TEIL	YOKE-SUPPLEMENTARY BOARD NO SPARE PART
0030.000		29501-082.40		BEDIENEINHEIT	CONTROL UNIT
0030.100		29303-168.17		CINCHBUCHSE 3-FACH	CINCH SOCKET 3-FOLD
0030.200		29303-390.41		KOPFHOERERBUCHSE	EAR PHONE SOCKET
0030.300	△	29703-291.71		NETZSCHALTER ECO O.W.	POWER SWITCH ECO
0030.500		29703-357.01	4	TASTSCHALTER	KEY SWITCH
0030.600		29501-591.06		TASTENSATZ	KEY SET
0047.000		29633-435.11		TASTENKNOPF NETZ	KEY BUTTON MAINS
0048.000	△	8290-991-316		NETZKABEL KPL.	POWER CABLE CPL GWN9.22
0050.000		29642-061.11		TELEPILOT TP 900	REMOTE CONTROL TP 900
		29305-122.11	X	BILDROHRPLATTE	PICTURE TUBE BOARD
		29701-094.16	X	CHASSIS-FS-STEREO CUC 6331 KEIN E-TEIL	CHASSIS TV STEREO CUC 6331 NO SPARE PART
				X = SIEHE GESONDERTE E-LISTE	X = SEE SEPARATE PARTS LIST

POS. NR. POS. NO.	SACHNUMMER PART NUMBER	BEZEICHNUNG DESCRIPTION	POS. NR. POS. NO.	SACHNUMMER PART NUMBER	BEZEICHNUNG DESCRIPTION
D 1	8309-215-817	DIODE 1 N 5817 -GA PHI	T 1	8302-800-108	TRANS.J 108 PHI
D 2	8309-215-817	DIODE 1 N 5817 -GA PHI	TR 1	29201-468.11	N/S-KORREKTURTRAFO T1
IC 84001	8305-367-530	IC TFMS 5300	TR 2	29201-468.12	N/S-ANSTEURTRAFO 16KHZ
L 1	09241-211.02	DROSSEL 330UH TDK			

1	29625-655.04	29625-655.03
1.3	29628-715.51	
1.4	29628-715.52	
1.5	29633-248.01	
2	29625-673.02	29625-662.01
2.1	29602-603.51	
47	29633-435.11	

Es gelten die Vorschriften und Sicherheitshinweise gemäß dem Service Manual "Sicherheit", Sach-Nummer 72010-800.00, sowie zusätzlich die eventuell abweichenden, landesspezifischen Vorschriften!

The regulations and safety instructions shall be valid as provided by the "Safety" Service Manual, part number 72010-800.00, as well as the respective national deviations.

GRUNDIGErsatzteilliste
Spare Parts List

D Btx * 32700 #

4 / 96

SYDNEY ST 872 TEXT
SYDNEY ST 872/8 TEXTSACH-NR. / PART NO.: 9.21532-01.75 BESTELL-NR. / ORDER NO.: G.CD 8675 COSMOS-SCHWARZ/COSMOS BLACK
SACH-NR. / PART NO.: 9.21532-02.24 BESTELL-NR. / ORDER NO.: G.CD 8724 NBF.
SACH-NR. / PART NO.: 9.21532-02.75 BESTELL-NR. / ORDER NO.: G.CD 8775 COSMOS-SCHWARZ/COSMOS BLACK

POS. NR. POS. NO.	ABB. FIG.	SACHNUMMER PART NUMBER	ANZ. QUA.	BEZEICHNUNG D	DESCRIPTION GB
0001.000		29625-655.01		GEHAEUSE LACKIERT 01/02.75	HOUSING LACQUERED 01/02.75
0001.000		29625-655.03		GEHAEUSE LACKIERT 02.24	HOUSING LACQUERED 02.24
0001.100		29602-603.51		GRUNDIG-EMBLEM	GRUNDIG EMBLEM
0001.200		27041-217.01		DRUCKSCHNAPPER	PRESSURE SNAPPER
0001.300		29608-864.01	4	SOCKELEINLAGE	BASE INSERT
0001.400		29628-707.51		GITTER KPL LINKS 01/02.75	GRILLE CPL., LEFT 01/02.75
0001.400		29628-707.59		GITTER KPL LINKS 02.24	GRILLE CPL., LEFT 02.24
0001.500		29628-707.52		GITTER KPL RECHTS 01/02.75	GRILLE CPL., RIGHT 01/02.75
0001.500		29628-707.60		GITTER KPL RECHTS 02.24	GRILLE CPL., RIGHT 02.24
0003.000		29633-235.01		INFRA-FENSTER DRUCK KPL.	INFRA WINDOW PRINT CPL.
0004.000		29633-281.01		KLAPPE DRUCK KPL.	FLAP PRESSURE CPL.
0005.000		29625-658.01		LENDE 01/02.75	MASK 01/02.75
0005.000		29625-658.52		LENDE 02.24	MASK 02.24
0006.000		29628-548.01	2	CHASSISBEFESTIGUNG	CHASSIS FIXING
0007.000		19104-029.97	2	STANDARD-HOCHTONLAUTSPRECHER	STANDARD TWEETER D 55
0008.000		19136-008.97	2	LAUTSPRECHER	LOUDSPEAKER
0009.000		29631-707.01		RUECKWAND 01/02.75	REAR PANEL 01/02.75
0009.000		29631-707.03		RUECKWAND 02.24	REAR PANEL 02.24
0010.000		29618-121.04		AUFKLEBER GERAETETYP 01.75	ADHESIVE LABEL;STICKER 01.75
0010.000		29618-122.04		AUFKLEBER GERAETETYP 02.24/75	ADHESIVE LABEL;STICKER 02.24/75
		29656-003.67		MONTAGEZUBEHOER F.BILDROHR KEIN E-TEIL	MOUNTING ACCESSORIES FOR CRT NO SPARE PART
0021.000		29607-296.01	4	SPULENKLAMMER	COIL CLAMP
0024.000	△	09246-191.75		ENTMAGNETISIERUNGSSPULE	DEGAUSSING COIL
0025.000	△	8300-068-202		BILDR. A68ESF202X11	PICT.TUBE A68ESF202X11
0026.000	△	29201-360.02		ANODENKAPPE MIT HOCHSPG.-KABEL	C.R.T. SOCKET
0030.000		29501-082.41		BEDIENEINHEIT	CONTROL UNIT
0030.600		29501-592.51		TASTENSATZ MIT RAHMEN	KEY SET WITH FRAME
		29304-019.95		MOEVEN-ENTZERRUNGSPLATTE KEIN E-TEIL	YOKE-SUPPLEMENTARY BOARD NO SPARE PART
0047.000		29633-502.11		TASTENKNOPF NETZ	KEY BUTTON MAINS
0048.000	△	8290-991-316		NETZKABEL KPL.	POWER CABLE CPL GWN9.22
0050.000		29642-061.11		TELEPILOT TP 900	REMOTE CONTROL TP 900
		29305-122.05	X	BILDROHRPLATTE BM 01.75	PICTURE TUBE BOARD 01.75
		29305-122.11	X	BILDROHRPLATTE BM 02.24/75	PICTURE TUBE BOARD 02.24/75
		21532-941.01		BEDIENUNGSANLEITUNG 01.75	INSTRUCTION MANUAL 01.75
		21532-941.02		BEDIENUNGSANLEITUNG 02.24/75	INSTRUCTION MANUAL 02.24/75
		29701-094.16	X	CHASSIS-FS-STEREO 01.75 CUC 6331 KEIN E-TEIL	CHASSIS TV STEREO 01.75 CUC 6331 NO SPARE PART
		29701-094.17	X	CHASSIS-FS-STEREO 02.24/75 CUC 6331 KEIN E-TEIL	CHASSIS TV STEREO 02.24/75 CUC 6331 NO SPARE PART
				X = SIEHE GESONDERTE E-LISTE	X = SEE SEPARATE PARTS LIST

POS. NR. POS. NO.	SACHNUMMER PART NUMBER	BEZEICHNUNG DESCRIPTION
D 1	8309-215-817	DIODE 1 N 5817 -GA PHI
D 2	8309-215-817	DIODE 1 N 5817 -GA PHI
IC 84001	8305-367-530	IC TFMS 5300
L 1	09241-211.02	DROSSEL 330UH TDK
T 1	8302-800-108	TRANS.J 108 PHI
TR 1	△ 29201-468.11	N/S-KORREKTURTRAFO T1
TR 2	△ 29201-468.12	N/S-ANSTEURTRAFO 16KHZ

POS. NR. POS. NO.	SACHNUMMER PART NUMBER	BEZEICHNUNG DESCRIPTION
----------------------	---------------------------	----------------------------

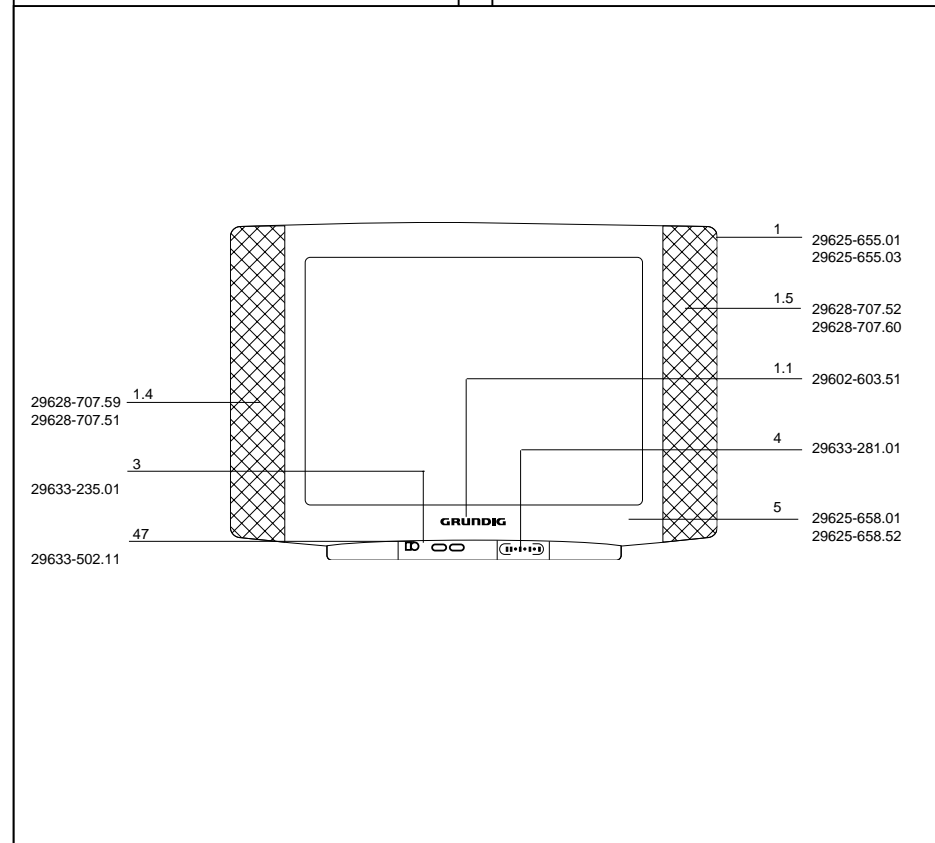

Es gelten die Vorschriften und Sicherheitshinweise gemäß dem Service Manual "Sicherheit", Sach-Nummer 72010-800.00, sowie zusätzlich die eventuell abweichenden, landesspezifischen Vorschriften!



The regulations and safety instructions shall be valid as provided by the "Safety" Service Manual, part number 72010-800.00, as well as the respective national deviations.

GRUNDIGErsatzteilliste
Spare Parts List

D Btx * 32700 #

4 / 96

ST 72-760 TEXT
ST 72-760/8 TEXTSACH-NR. / PART NO.: 9.21521-0169 BESTELL-NR. / ORDER NO.: G.CD 6169 ANTHRAZIT-BLUE
SACH-NR. / PART NO.: 9.21521-0269 BESTELL-NR. / ORDER NO.: G.CD 7069 ANTHRAZIT-BLUE

POS. NR. POS. NO.	ABB. FIG.	SACHNUMMER PART NUMBER	ANZ. QUA.	BEZEICHNUNG D	DESCRIPTION GB
0001.000		29625-648.03		GEHAEUSEVORDERTEIL OFB .01	CABINET FRONT .01
0001.000		29625-648.01		GEHAEUSEVORDERTEIL OFB .02	CABINET FRONT .02
0001.100		29602-603.51		GRUNDIG-EMBLEM	GRUNDIG EMBLEM
0001.200		29628-660.51		GITTER KPL. LINKS	GRILLE CPL. LEFT
0001.300		29628-660.52		GITTER KPL. RECHTS	GRILLE CPL. RIGHT
0001.400		27041-217.01		DRUCKSCHNAPPER	PRESSURE SNAPPER
0001.500		29633-517.51		ABDECKUNG DRUCK KPL	COVER PRESSURE CPL.
0001.600		29633-521.51		KLAPPE DRUCK KPL	FLAP PRESSURE CPL.
0007.000		19126-024.97	2	LAUTSPRECHER	LOUDSPEAKER
0008.000		29628-548.01	2	CHASSISBEFESTIGUNG	CHASSIS FIXING
0009.000		29631-699.01		GEHAEUSERUECKTEIL	CABINET BACK
0010.000		29618-106.14		AUFKLEBER TYPE .01	ADHESIVE LABEL;STICKER .01
0010.000		29618-111.14		AUFKLEBER TYPE .02	ADHESIVE LABEL;STICKER .02
0012.000		29501-626.01		TASTENSATZ	KEYS SET
		29656-003.68		MONTAGEZUBEHOER F.BILDROHR KEIN E-TEIL	MOUNTING ACCESSORIES FOR CRT NO SPARE PART
0021.000		29607-296.01	4	SPULENKLAMMER	COIL CLAMP
0024.000	△	09246-191.75		ENTMAGNETISIERUNGSSPULE	DEGAUSSING COIL
0025.000	△	8300-068-202		BILDR.A68ESF202X11	PICT.TUBE A68ESF202X11
0026.000		29201-360.02		ANODENKAPPE MIT HOCHSPG.-KABEL .02	C.R.T. SOCKET .02
		29304-019.95		MOEVEN-ENTZERRUNGSPLATTE KEIN E-TEIL	YOKE-SUPPLEMENTARY BOARD NO SPARE PART
0030.000		29501-082.31		BEDIENEINHEIT	CONTROL UNIT
0030.100		29303-168.17		CINCHBUCHSE 3-FACH	CINCH SOCKET 3-FOLD
0030.200		29303-390.41		KOPFHOERERBUCHSE	EAR PHONE SOCKET
0030.300		29501-599.01		S-BUCHSEN-ABDECKUNG	S-SOCKET-COVER
0030.400	△	29703-291.21		NETZSCHALTER	POWER SWITCH
WW.	△	29703-291.31		NETZSCHALTER	POWER SWITCH
0030.600		29703-357.01	4	TASTSCHALTER	TACT SWITCH
0043.000		29501-573.01		TASTENKNOPF NETZ	KEY HEAD MAINS
0044.000	△	8290-991-316		NETZKABEL KPL.	POWER CABLE CPL GWN9.22
0045.000		29642-059.06		TELEPILOT TP 720	REMOTE CONTROL TP 720
		29305-122.05	X	BILDROHRPLATTE BM	PICTURE TUBE BOARD
		21521-941.01		BEDIENUNGSANLEITUNG .01	INSTRUCTION MANUAL .01
		21521-941.02		BEDIENUNGSANLEITUNG .02	INSTRUCTION MANUAL .02
		29701-094.14	X	CHASSIS-FS-STEREO .01 CUC 6331 KEIN E-TEIL	CHASSIS-TV-STEREO .01 CUC 6331 NO SPARE PART
		29701-094.15	X	CHASSIS-FS-STEREO .02 CUC 6331 KEIN E-TEIL	CHASSIS-TV-STEREO .02 CUC 6331 NO SPARE PART
				X = SIEHE GESONDERTE E-LISTE WW. = WAHLWEISE	X = SEE SEPARATE PARTS LIST WW. = OPTIONAL

POS. NR. POS. NO.	SACHNUMMER PART NUMBER	BEZEICHNUNG DESCRIPTION	POS. NR. POS. NO.	SACHNUMMER PART NUMBER	BEZEICHNUNG DESCRIPTION
C 1824	8668-203-023	ABBLOCK-C 0,1 UF -GR	R 1850	△ 8765-049-157	MSW 0414 3,3 MOHM VDE B
D 1	8309-215-817	DIODE 1 N 5817 -GA PHI	T 1	8302-800-108	TRANS.J 108 PHI
D 2	8309-215-817	DIODE 1 N 5817 -GA PHI	TR 1	△ 29201-468.11	N/S-KORREKTURTRAFO T1
D 1860	8309-944-601	LE DIODE TLHR 4601 TFK	TR 2	△ 29201-468.12	N/S-ANSTEURTRAFO 16KHZ
IC 1800	8305-367-530	IC TFMS 5300			
L 1	09241-211.02	DROSSEL 330UH TDK			

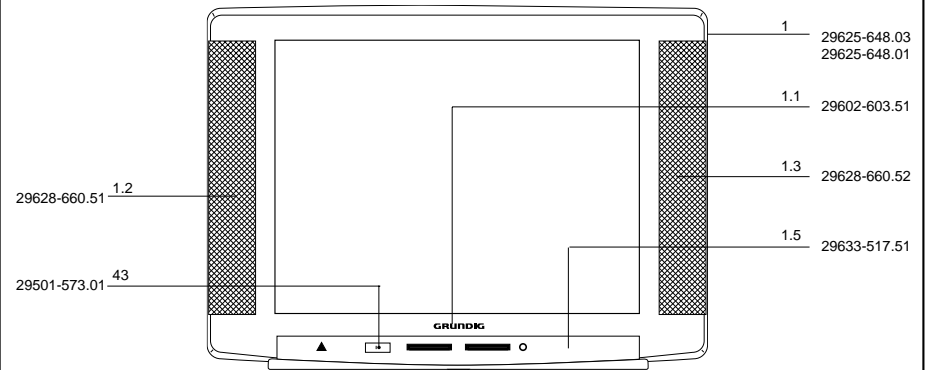

Es gelten die Vorschriften und Sicherheitshinweise gemäß dem Service Manual "Sicherheit", Sach-Nummer 72010-800.00, sowie zusätzlich die eventuell abweichenden, landesspezifischen Vorschriften!



The regulations and safety instructions shall be valid as provided by the "Safety" Service Manual, part number 72010-800.00, as well as the respective national deviations.



ⓓ Btx * 32700 #

4 / 96

ST 70-705/8 TEXT

SACH-NR. / PART NO.: 9.21513-0275
BESTELL-NR. / ORDER NO.: G.CD 4475 COSMOS SCHWARZ/COSMOS BLACK

POS. NR. POS. NO.	ABB. FIG.	SACHNUMMER PART NUMBER	ANZ. QUA.	BEZEICHNUNG ⓓ	DESCRIPTION ⓖⓑ
0001.000		29635-127.04		GEHAEUSEVORDERTEIL KPL	CABINET FRONT
0001.100		29602-603.51		GRUNDIG-EMBLEM	GRUNDIG EMBLEM
0001.200		29633-374.01		INFRA-FENSTER	INFRA-WINDOW
0001.300		29633-403.53		ABDECKUNG DRUCK KPL	COVER
0001.400		29633-372.01	2	GITTER	GRILLE
0007.000		29633-426.01		BUCHSENABDECKUNG	SOCKET COVER
0008.000		29501-613.51		TASTENKNOPF NETZ	KEY BUTTON
0010.000		29631-699.07		GEHAEUSERUECKTEIL	REAR PANEL
0014.000		19126-024.97	2	LAUTSPRECHER	LOUDSPEAKER
0015.000		29501-082.11		BEDIENEINHEIT	CONTROL UNIT
0015.100		29303-168.26		CINCHBUCHSE 3-FACH	CINCH SOCKET
0015.200		29303-390.41		KOPFHOERERBUCHSE	EAR PHONE SOCKET
0015.300		29703-357.11		TASTSCHALTER	KEY SWITCH
0016.000		29501-611.51		TASTENSATZ	KEYS SET
		29656-003.65		MONTAGE-ZUBEHOER F.BILDROHR KEIN E-TEIL	MOUNTING ACCESSORIES FOR CRT NO SPARE PART
0020.000		29628-548.01	2	CHASSISBEFESTIGUNG	CHASSIS FIXING
0021.000		29607-219.01	8	SPULENHAKEN	COIL HOOK
0024.000	⚠	09246-191.75		ENTMAGNETISIERUNGSSPULE	DEGAUSSING COIL
0025.000	⚠	8300-030-435		BILDR.A 66 EAK 71X01 WW.	CRT A 66 EAK 71X01 OPT
0026.000	⚠	29201-360.02		ANODENKAPPE MIT HOCHSPG.-KABEL	C.R.T. SOCKET
0030.000	⚠	8290-991-316		NETZKABEL KPL	POWER CABLE CPL GWN9.22
0031.000		29642-059.06		TELEPILOT TP 720	REMOTE CONTROL TP 720
		29305-122.05	X	BILDROHRPLATTE BM	PICTURE TUBE BOARD
		21513-941.01		BEDIENUNGSANLEITUNG	INSTRUCTION MANUAL
		29701-094.05	X	CHASSIS-FS-STEREO CUC 6330 KEIN E-TEIL	CHASSIS TV STEREO CUC 6330 NO SPARE PART
				X = SIEHE GESONDERTE E-LISTE	X = SEE SEPARATE PARTS LIST
C 41504		8668-203-023		ABBLOCK-C 0,1 UF -GR	BLOCKING CAPACITOR 0,1 UF -GR
IC 84001		8305-367-530		IC TFMS 5300	IC TFMS 5300

